



A Donaldson Company

A WORLD LEADER IN FUME
EXTRACTION TECHNOLOGY

T 100

ELECTRONICS

Last Updated on 13.07.2018



Centralised tip extraction for lead and lead free solder applications.

The T 100 high vacuum units are designed to extract and filter fumes and debris through small bore hoses and attachments. Ideally suited for soldering iron tip extraction, vac pens and any application requiring close proximity, micro extraction.

Due to high concentration of debris generated from up to 100 operators, this system has been designed to keep the unit compact, but still utilise a comprehensive filter system. With this in mind, the unit incorporates a facility for retaining a high concentration of particulate within the filter enclosure.

Technology



HEPA filter



Reverse flow air technology



Advanced carbon filter technology



ProTECT service plan



SureCHECK quality standard

Key Features of the T100

Reverse flow
Standard

Low noise levels
Standard

Filter change indicator
Standard

Small footprint
Standard

Brushless motor
Standard

Tip extraction iron kit
Optional

Contact BOFA at <https://bofainternational.com/en/contact/>

<https://bofainternational.com/en/portal/datasheets/t100/>







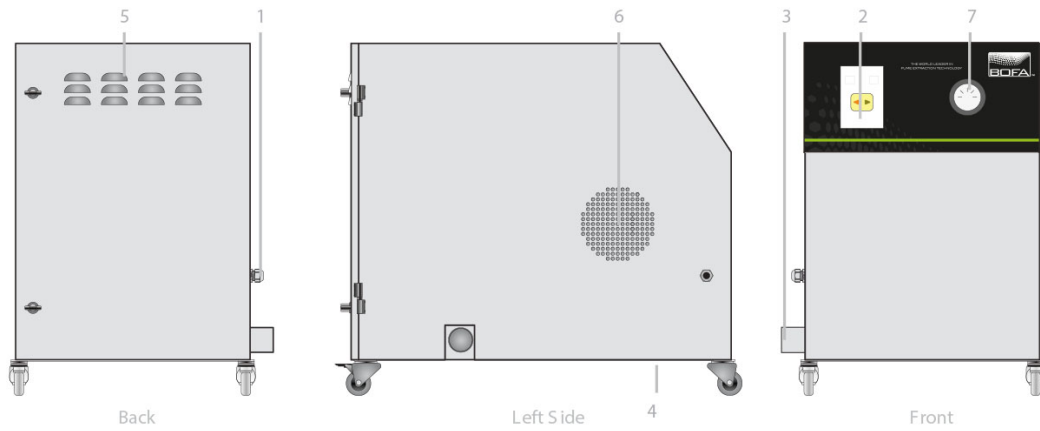

Technical specification

- 1. Mains cable inlet
- 2. Main switch
- 3. 50mm inlet
- 4. Exhaust outlet
- 5. Motor cooling outlet
- 6. Motor cooling inlet
- 7. Pressure gauge



Airflow through filters

-  Chemical filter
-  HEPA filter
-  Pre filter
-  Clean air
-  Contaminated air
-  Particulate

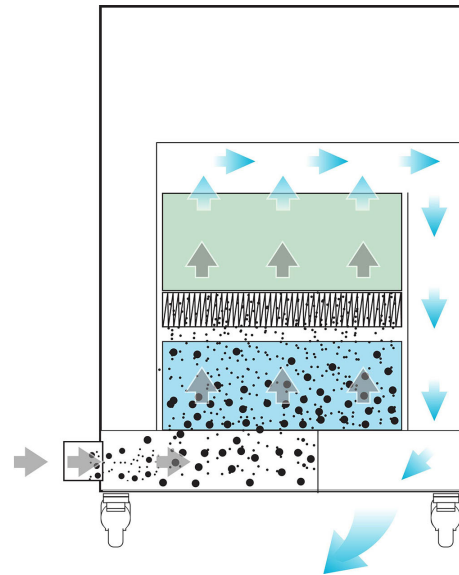

Technical Data

	EU	US
Dimensions (HxWxD)	700 x 475 x 770 mm	27.6 x 18.7 x 30.3"
Cabinet Construction	Powder coated mild steel	Powder coated mild steel
Recommended flow rate with filters fitted (per tip)	22 L/M	22 L/M
Electrical data	415v 3Ph 50Hz / 2.2 kw / 5.6A	415v 3Ph 50Hz / 2.2 kw / 5.6A
Noise level	< 70dBA*	< 70dBA*
Weight	80kg	176lbs
Pre filter efficiency	85% @ 0.8 microns	85% @ 0.8 microns
HEPA filter efficiency	99.997% @ 0.3 microns	99.997% @ 0.3 microns
Gas Filter	Treated activated carbon	Treated activated carbon
Approvals	CE	CE

Unit specifications

	415v
Maximum number of Soldering Irons	100

Unit part numbers

Model	Voltage	Part no.
T 100 Powder coated	415v	E0642A0000

Filter part numbers

Model	Pre filter part no.	Combined filter part no.
T 100	A1030165	A1030164

Universal adjustable iron kit part numbers

Model	Part number
non ESD	A1090025
ESD	A1090026

Universal iron kit components (Maximum number of soldering irons - 100)

1. 6mm stainless steel tube
220mm long

5. 1 x clear plug

2. 6mm stainless steel tube
110mm long

6. 2.5m of 6.5mm x 4.5mm
silicone hose

3. 5mm stainless steel tube
200mm long

7. Small brass brush

4. 4 x E clips

8. Rubber tube to iron strap

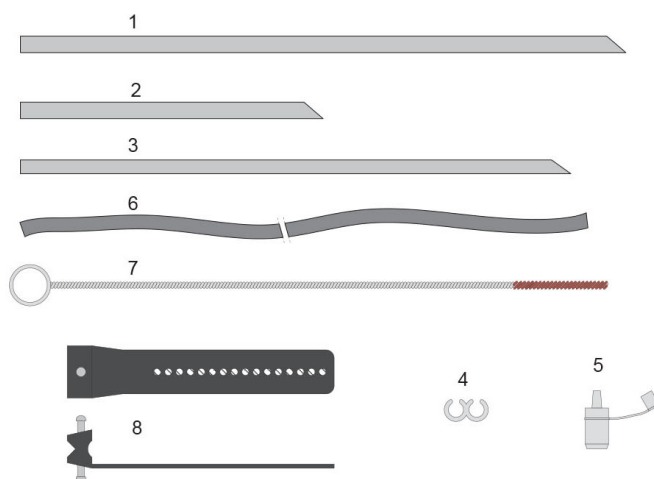

Other languages

T 100
[French](#)

Datasheet correct at time of publishing.

The carbon used in BOFA units is capable of removing a wide range of VOC's, however it is the responsibility of the user to ensure the carbon is suitable for their application. For specific applications, please contact us for details.

Think before you print! Please consider the environment before printing this document.

