

Developing MEKO-Free Silicone FIPG

Introduction

Silicone FIPG are used for a variety of sealing and adhesion applications such as in automotive engines, transmissions, etc., areas thanks to their flexibility when cured and excellent heat and chemical resistance, and ThreeBond has been developing products using them to meet customer needs.

Meanwhile, environmental regulations have been growing more and more strict across the world, with chemical substance risk assessments and other mandates being required in Japan, as well, to prevent occupational risk. European nations are particularly conscious of the work environment, establishing environmental regulations and chemical substance registration/management systems well ahead of the rest of the world.

The silicone FIPG currently in extensive use releases methyl ethyl ketoxime (hereafter, abbreviated as MEKO) as a by-product of the curing reaction, and this has been designated a hazardous substance in Europe (Legal Reference 1, 2, 3). In this document, we will introduce MEKO-free silicone FIPG made in response to these European working environment regulations.

Table of Contents

Introduction.....	1	4. Product Lineup.....	5
1. Background.....	2	5. ThreeBond 1217M Evaluations	6
2. FIPG	2	6. ThreeBond 1217P Evaluations	7
3. Required Characteristics	3	Closing	8

1. Background

1-1 Environmental Regulations

Recent years have seen stricter and stricter regulations related to chemical substances. These are a part of a global effort to appropriately manage chemical substances in order to improve the working environment and save the earth. European Union, in particular, has been ahead of the rest of the world in terms of management and implementation of environmental regulations, continuing revisions over time to create a global standard for chemical substances. Automobile and other manufacturing industries must comply with a variety of countries' environmental regulations, and even chemical industry manufacturers are required to move forward on product development that complies with these regulations.

1-2 Automotive Industry Efforts

In order to both reduce CO₂ emissions and use renewable petroleum substitutes within automobile and other manufacturing industries, hybrid (HV/PHV), electric (EV), fuel cell (FCV) and other eco-friendly vehicles have been released one after another, and their market share continues to grow. Along with this, competition continues to increase in terms of reduction in fuel consumption and other environmental considerations.

Compliance with conservation efforts applies not only to completed vehicles (products), but also to continuing workload reduction and simplification across the manufacturing line. There has been considerable focus on environmentally regulated substances, including organic solvents.

2. FIPG

2-1 FIPG

FIPG are liquid gaskets (FIPG: Formed-In-Place Gaskets) are used in the process where liquid materials are used for coating/applying to the flange where these then cure to perfectly shaped sealing/adhesive. Currently, RTV silicone (RTV: Room Temperature Vulcanizing) is the mostly widely used type of material for FIPG, which includes considerable use of oxime types which release MEKO during the curing reaction.

2-2 FIPG Seal Theory

While solid gaskets maintain a seal through repulsive force, FIPG seal oily mediums mainly through bonding, adhesion, viscoelasticity and cohesive force. These characteristics must be tuned excellent in order to maintain a fully sealed component (Figs. 2-1, 2-2).

Applications: Adhesive sealant for oil pans, chain cases, etc.

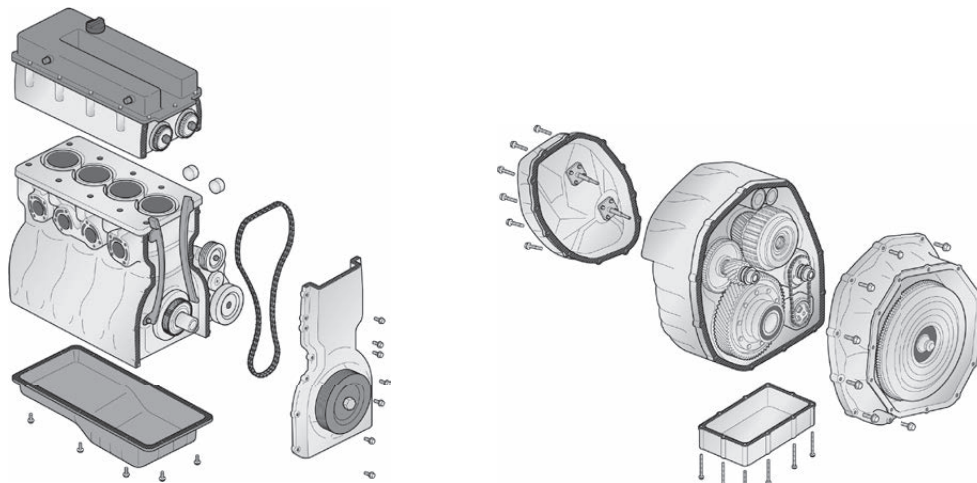

Fig. 1 Parts Where FIPG are Used

Solid Gaskets

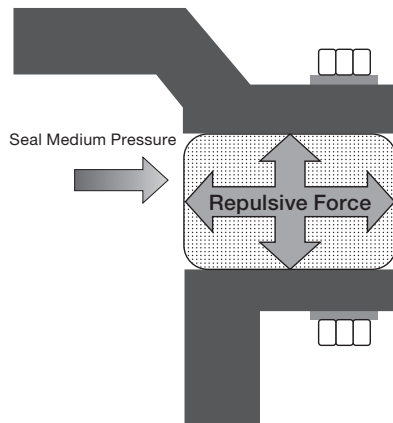

Fig. 2-1 Solid Gasket Seal Theory

Liquid Gaskets (FIPG)

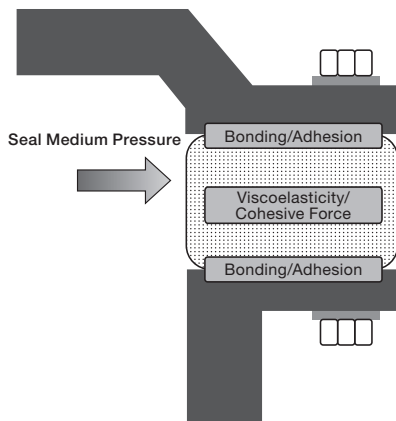

Fig. 2-2 Liquid Gasket (FIPG) Seal Theory

2-3 Types of Leaks

The three main types of leaks are permeation (inner layer) leakage, where the inside of the gasket is penetrated by the medium, burst leakage, where the gasket itself breaks, and junction leakage, where leakage occurs at the interface of the gasket and the flange (Fig. 3).

There are various causes of leakage, and FIPG are important in prevention because of their durability for the sealed medium, ability to follow flange vibrations and opening deviations and their ability to adhere to the flange.

Permeation (inner surface) Leakage

Leaky where the interior of the gasket is penetrated
 → Mainly due to the gasket having insufficient chemical resistance

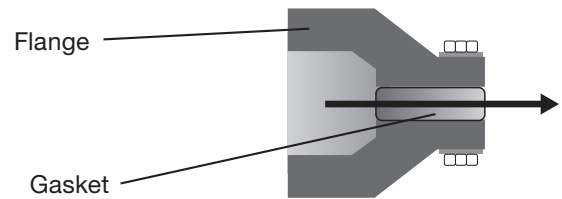

Burst Leakage

Leaky from the broken surface of the gasket
 → Mainly due to gasket deformation ability, flange vibration

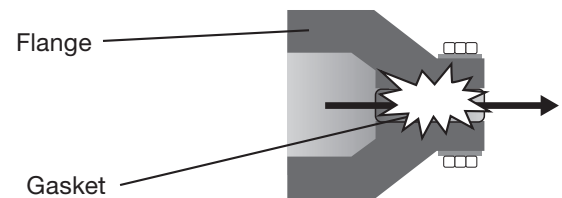

Junction Leakage

Leaky from the interface of the gasket and the flange
 → Mainly due to insufficient bonding/adhesion
 *Adhesion for each part is vital

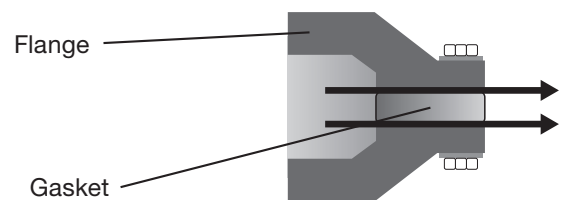

Fig. 3 Types of Leaks

3. Required Characteristics

3-1 MEKO Positioning in Europe

European union is ahead of the world in terms of enforcement and management standards of environmental regulations, and this management and these standards are strict. In Europe, MEKO is designated as a category 2 carcinogen (Legal Reference 3). MEKO is released as a gaseous component in the condensation reaction during curing of the FIPG (MEKO-releasing types) used most extensively throughout the world.

Therefore, an FIPG which does not release gaseous MEKO during condensation is vital in order to conform to European standards.

3-2. Durability versus Oil

Silicone FIPG is mainly used as an oil sealant in engines, transmissions, etc. This means it is important that strength and elasticity do not suffer with high temperatures (120 °C or more), while also ensuring effective adhesion (bonding) to the part is maintained in order to ensure proper sealant application.

3-3 High Elongation

FIPG are mainly used in vehicle parts (such as engines or transmissions) that vibrate or are subjected to impact, so the ability to follow vibrations and deviations in openings in those parts is required in addition to good adhesion. Oil leaks occur due to FIPG fractures when deformation ability is insufficient even if adhesion is sufficient.

3-4 Adhesion to Oily or Dirty Parts

Engine blocks, transmission casings and similar parts are usually produced by molding and cutting iron or aluminum die cast. A certain amount of the cutting oil used for this remains on the flange even after cleaning. Additionally, various industrial equipment in operation within an engine manufacturing plant scatter lubricant oil, creating a mist (oil becomes small particles that float through the air) that attaches to adherends and causes dirt to remain. This negatively impacts FIPG adhesion, even leading to leakage.

Currently, degreasing processes using organic solvents are used to remove oil attached to adherends, but as these processes are reduced due to environmental concerns, this previously removed oil and dirt remains on those surfaces.

Oil or dirt on an adherend are commonly known to significantly reduce adhesive strength, which may also lead to market defects such as oil bleed. This means that FIPG require robust improvement of adhesion to prevent these issues (see Figure 4 for determination of adhesion criteria).

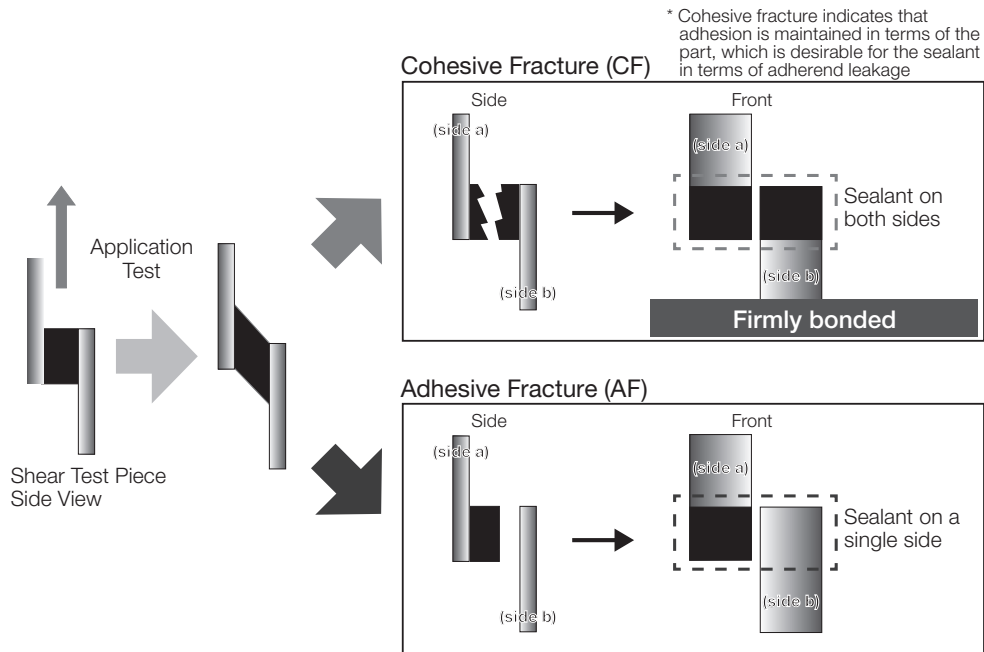

Fig. 4 Cohesive and Adhesive Fractures

4. Product Lineup

Here, we explore the features and properties of our new products, ThreeBond 1227H and ThreeBond 1217P (hereafter abbreviated to TB1227H and TB1217P, respectively), which overcome the issues presented above (Table 1 & 2).

4-1 TB1227H (Alcohol-Releasing)

Instead of MEKO classified as a carcinogen in Europe, this FIPG releases gaseous alcohol during the condensation. It features improved curing speed, which has been an issue in alcohol-releasing types. Compared to conventional FIPG, it features oil resistance and oily surface adhesion that make it excellent for sealing and adhesion applications where conventional FIPG products do not produce sufficient adhesion to oil and dirt which are the result of changes to degreasing processes.

4-2 TB1217P (MIBKO-Releasing)

Instead of MEKO classified as a carcinogen in European union, this FIPG releases MIBKO (methyl isobutyl ketoxime) as a gaseous component generated in condensation. It has better curability than alcohol-releasing type and cures at the same speed as MEKO-releasing FIPG. Additionally, it features oily surface adhesion that make it excellent for sealing and adhesion applications where conventional FIPG products do not produce sufficient adhesion to oil and dirt which are the result of changes to degreasing processes.

* Effectiveness varies depending on oil type. Effectiveness for the oil type, concentration and other factors must be checked before use after degreasing.

Table 1 Properties

Property	Unit	Conventional Product A	TB1227H	Conventional Product B	TB1217P	Testing Method	Remarks
Curing Method	—	Alcohol-Releasing	Alcohol-Releasing	MEKO-Releasing	MIBKO-Releasing	—	—
Appearance	—	Black	Black	Gray	Black	3TS-2100-002	—
Viscosity	Pa·s	200	230	330	260	3TS-2F30-001	SOD
Specific gravity	—	1.47	1.39	1.36	1.36	3TS-2500-002	—
Tack free time	min	90	10	5	6	3TS-3130-003	—
Thick film curing performance	min	1.7	2.3	3.0	2.9	3TS-3160-005	1 Day

Curing conditions: 23°C, 50% RH

Table 2 Cured Material Characteristics

Property	Unit	Conventional Product A	TB1227H	Conventional Product B	TB1217P	Testing Method	Remarks
Hardness	—	A30	A58	A51	A57	3TS-2B00-004	—
Elongation Rate	%	420	280	470	430	3TS-4190-005	—
Tensile Strength	MPa	2.1	2.3	2.6	2.4	3TS-4190-005	—
Tensile Shear Bond Strength	MPa	1.7	1.8	2.6	1.9	3TS-4100-023	Al/Al

Curing conditions: 23°C, 50% RH×168h

Al: Aluminum

5. ThreeBond 1227H Evaluations

5-1 Chemical Resistance

The test specimens were cured at standard conditions (23°C, 50% RH×168 h), immersed in 120°C engine oil or coolant for 4 days, then checked for changes in physical properties.

TB1227H maintained better characteristics than conventional FIPG (Fig. 5-1).

TB1227H showed excellent engine oil resistance, maintaining incredible adhesion after the long-term immersion test (Fig. 5-2).

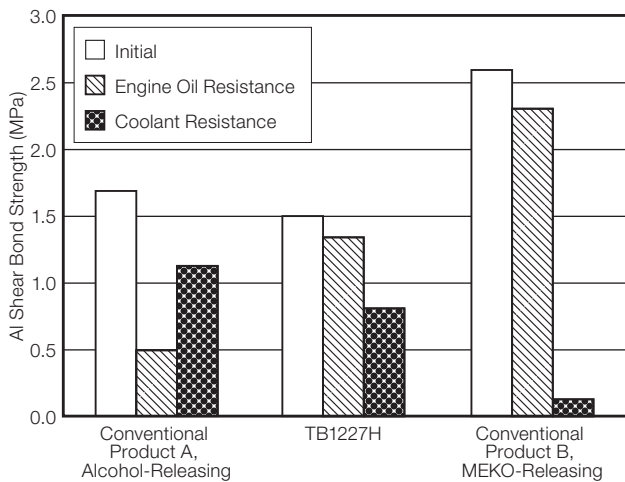

Fig. 5-1 TB1227H Chemical Resistance Test (Al/Al)

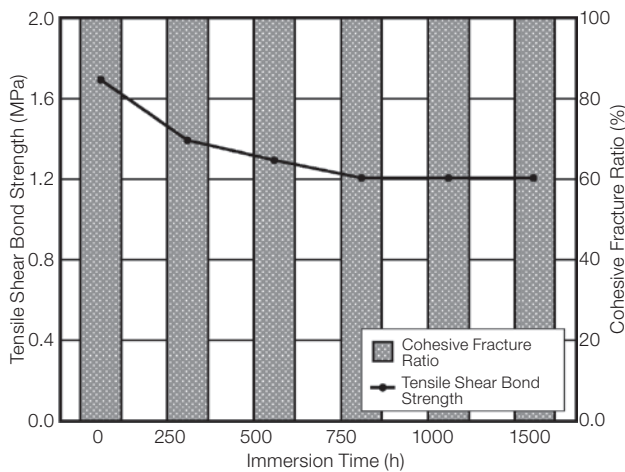

Fig. 5-2 TB1227H Long-Term Engine Oil Resistance Test (Al/Al)

5-2 Oily Surface Adhesion

To check adhesion to oily or otherwise dirty parts, engine oil was diluted to a specific concentration using a solvent, applied to an aluminum plate which was used as the test piece, then the tensile shear bond strength was checked.

Conventional FIPG

Shear bond strength did not decrease significantly, though the state of cohesive failure gradually decreased, becoming almost entirely adhesive fractures (AF) at around 5% (Fig. 6-1, 6-2).

TB1227H

Highly robust adhesive performance was maintained, with almost no reduction in shear bond strength or the cohesive fracture ratio until reaching an oily surface concentration of 10% (Figs. 6-1, 6-2).

The above study results indicate that TB1227H demonstrates better adhesive performance on oily surfaces than conventional FIPG products. The below study results indicate that TB1227H demonstrates better adhesive performance on oily surfaces than conventional FIPG products.

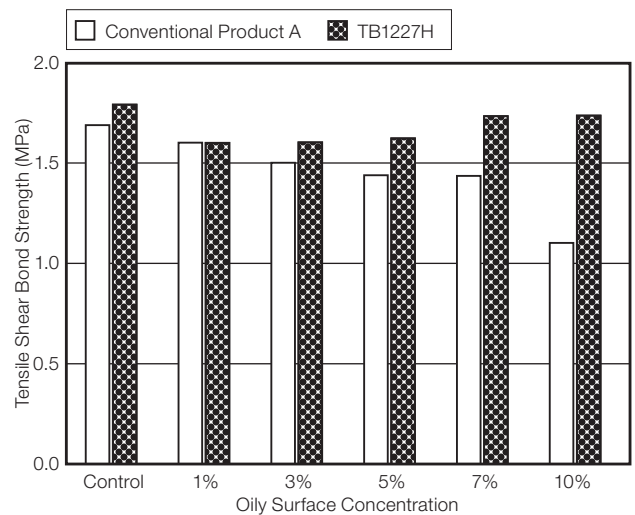

Fig. 6-1 Oily Surface Adhesion Test (Al/Al)

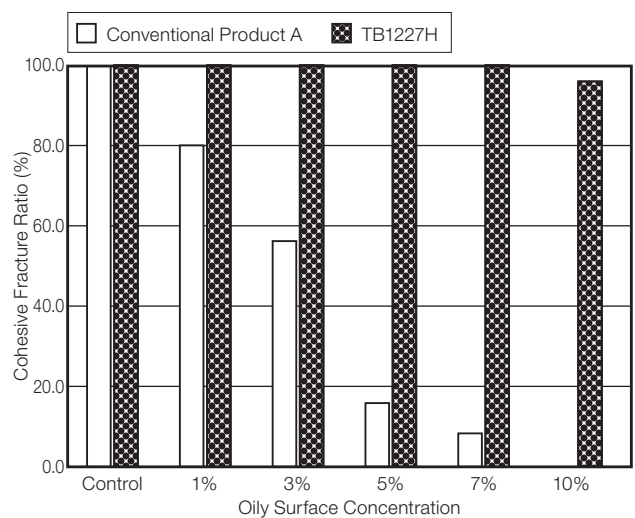

Fig. 6-2 Conventional Product (Alcohol-Releasing) Oily Surface Adhesion Test (Al/Al)

6. ThreeBond 1217P Evaluations

6-1 Oily Surface Adhesion

Engine oil was diluted to a specific concentration using a solvent, applied to an aluminum plate which was used as the test piece, then the tensile shear bond strength was checked.

■ Conventional FIPG

Shear bond strength and the cohesive fracture ratio all began to drop from an oily surface concentration of around 1%, becoming almost entirely adhesive fractures (AF) at around 5% (Fig. 7-1, 7-2).

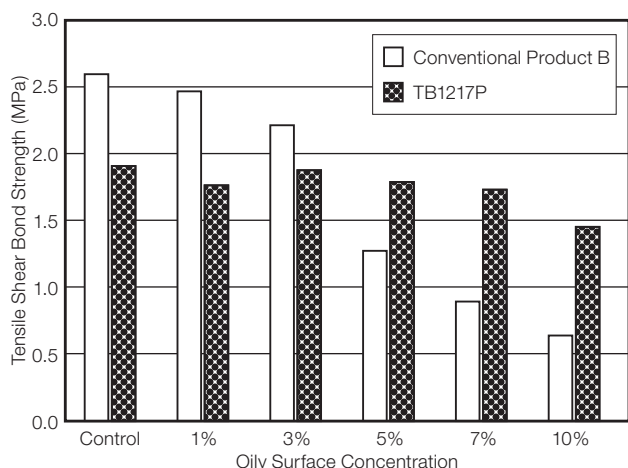

Fig. 7-1 TB1217P Oily Surface Adhesion Evaluations (Al/Al)

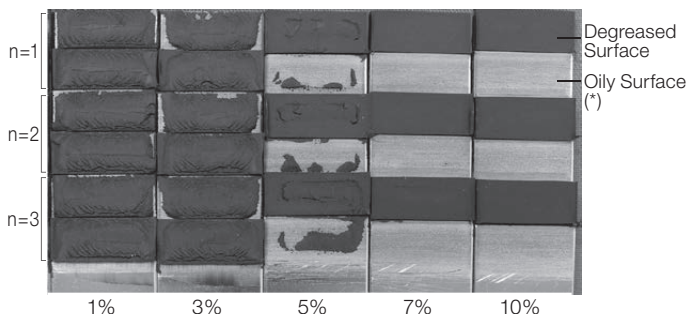

Fig. 7-2 Conventional FIPG Cohesive Fracture Ratio

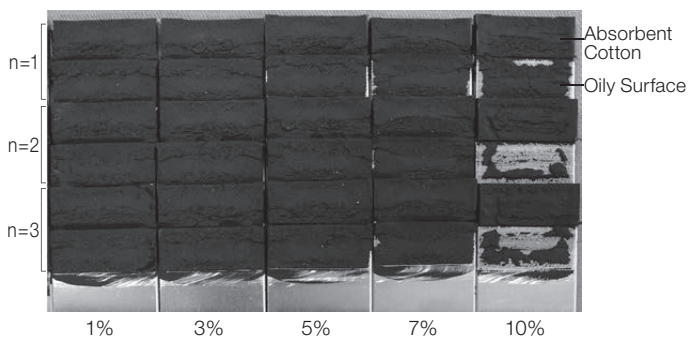

Fig. 7-3 TB1217P Cohesive Fracture Ratio

* See Fig. 4, page 4

■ TB1217P

Adhesive performance was maintained, with no reduction in tensile shear bond strength, shear elongation or the cohesive fracture ratio until reaching around a 7% oily surface (Fig. 7-1, 7-3).

Test results (Fig. 7-1, 7-2 and 7-3) showed that TB1217P demonstrates better adhesive performance on oily surfaces than conventional FIPG products.

6-2 Long-Term Durability

The test specimen was cured at standard conditions (23°C, 50% RH×168 h), immersed in 150°C engine oil over a long time period, then checked for changes in physical properties.

Shear bond strength equal or better than conventional FIPG was maintained, even after long-term immersion (Fig. 8-1).

Additionally, changes in physical characteristics due to long-term heat exposure were checked in a 150°C heat resistance test. Shear bond strength equal or better than conventional FIPG was maintained, even after long-term immersion (Fig. 8-2), just as in the engine oil immersion test.

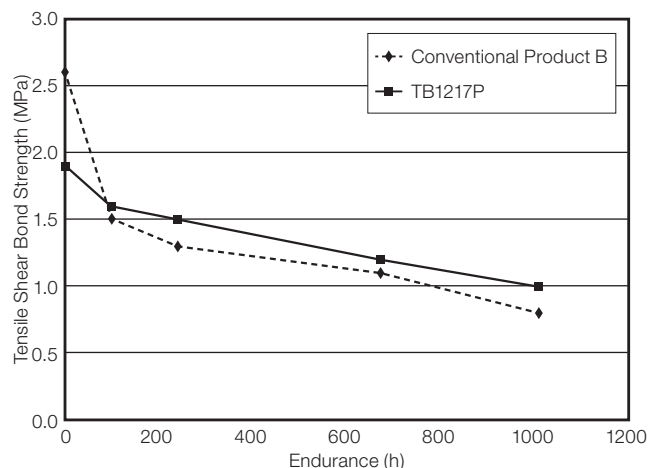

Fig. 8-1 TB1217P Long-Term Engine Oil Resistance Test

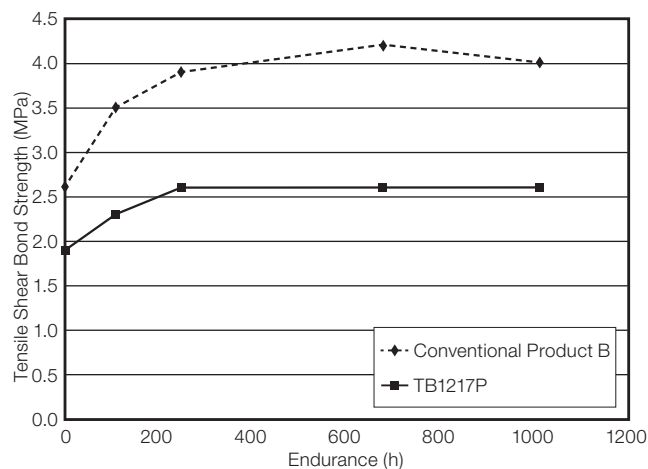

Fig. 8-2 TB1217P Long-Term Heat Resistance Test

Closing

Here, we have explored the superior oily surface adhesion of our MEKO-free TB1227H and TB1217P, which meet European chemical management standards. These products contribute to the reduction of both manufacturing processes and organic solvents used in those processes, thereby contributing to environmental conservation efforts. At ThreeBond, we will continue to develop products that meet customer needs while also taking work environment concerns into consideration.

<Legal References>

- 1) Dangerous Substances Directive” / Substance Directive 67/548/EEC
- 2) Dangerous Products Directive” / Preparation Directive 1999/45/EC
- 3) Classification Labelling and Packaging of substances and mixtures” / Regulation (EU) 1272/2008

ThreeBond Co., Ltd. R&D Headquarters
Transport Development Division, Development Section
Masao Inoue
Akihiro Koyama

