

ThreeBond TECHNICAL NEWS

Three Bond Technical News
Issued May 1, 1993

41

Next-generation gasket and its system

Introduction

Ever since Three Bond was founded, one of its missions has been to develop and provide sealants of many kinds, including liquid gaskets, to prevent leaks in industrial uses. Always we have accepted and met the challenge to develop new technologies by applying new ideas. This issue, which is focused on the next-generation gasket and the principles that underlie it, introduces five new technologies. We hope that they will help you to save labor and reduce costs.

Contents

Introduction.....	1
1. Floating Conformation OLGS	2
2. UV-OLGS (tentatively G-II).....	4
3. Rubber gasket provided with carrier (tentatively BECS).....	6
4. Super OLGS	8
5. Foaming OLGS.....	10
Conclusion	12

1. Floating Conformation OLGS

OLGS: On Line Gasket System

1-1 Background

Liquid gaskets include silicone, acrylic ester, synthetic rubber, and synthetic resin types, and OLGS is used in various fields of application of these liquid gaskets. In addition to high sealing performance, these liquid gaskets used for OLGS must provide various functions in materials, including vibration isolating properties.

OLGS is already deployed on a wide range of assembly lines, including transport machinery, electric, and electronics industries. However, numerous problems have occurred until now. For example, in production lines for transport machinery, the high contact pressure generated at the flange surface causes the gasket materials to flow out, resulting in leakage of oil and other fluids due to degraded sealing performance and increased vibration. On the other hand, also in the electric and electronics-related industries, "anti-oscillation" is assumed to be a significant factor; the concept of "Floating Conformation OLGS" is approved as the solution of various problems.

1-2 Overview of Floating Conformation OLGS

<Composition>

Under this system, 5 to 50 volume percent of rubber particles with an average diameter from 0.01 mm to 3.0 mm are dispersed in liquid gaskets.

Appropriate rubber material is selected for relevant liquid gaskets to blend for application.

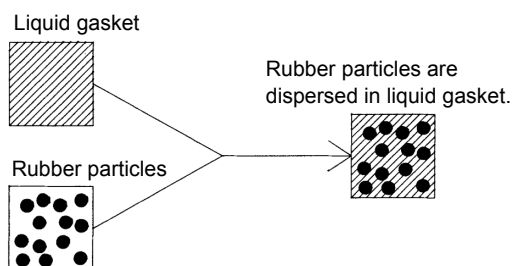

<Purpose>

OLGS prevents shifting and opening at the flange face, as well as vibration at the flange. The intervention of rubber particles between flanges retains a clearance to prevent direct contact between metals. This type of conformation is called Floating

Conformation.

1-3 Functions of Floating Conformation OLGS

Floating Conformation OLGS provides various effects below:

<Initial pressure resistance>

The leakage phenomenon at the flange joint before the liquid gaskets are cured is expressed as the following equation, applying Newton's Viscosity Law to laminar flow in capillaries.

$$Q = \frac{\pi R^4}{8 \eta} \cdot \frac{P}{L}$$

Q : amount of leakage
 η : viscosity of fluid
 R : radius of the pipe
 L : length of the pipe
 P : pressure difference between the both ends of the pipe

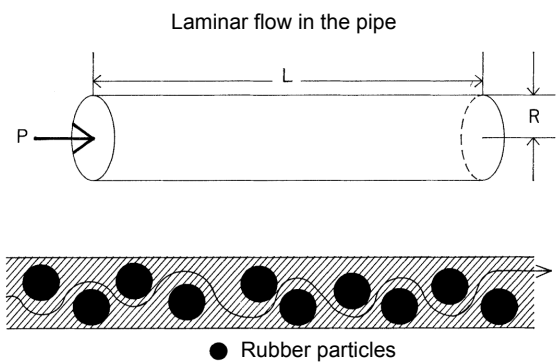

Rubber particles in the pipe with liquid significantly extends the distance that the fluid flows. In the above figure, this means that L (length of pipe) is increased. In addition, the width of the flow of liquid (i.e., radius R) decreases. Applying these conditions to the above-mentioned equation significantly reduces the value of Q (amount of leakage), increasing initial pressure resistance.

<Retention of Clearance>

Liquid gaskets are used at interfaces between parts that require sealing-up, as in automobile components such as cylinder head covers and oil pans. In sealing the boundary between two components with liquid gaskets, the required film thickness is held for some time when components are coated. But when components A and B are attached by fasteners such as bolts, as shown in the figure on the next page, the contact pressure at the interface often rises until components A and B are driven into contact with each other, squeezing the liquid gasket out of the flange face. To prevent such

metal contact phenomena, rubber particles are blended to the liquid gasket. The intervention of rubber particles between the flanges retains the clearance and maintains the required thickness of the liquid gasket film.

If metal contact occurs and adequate gasket film thickness cannot be maintained, the supply of liquid gasket material is blocked and leakage may occur. It is clear that eliminating metal contact helps significantly in preventing shifting and opening at the flange face.

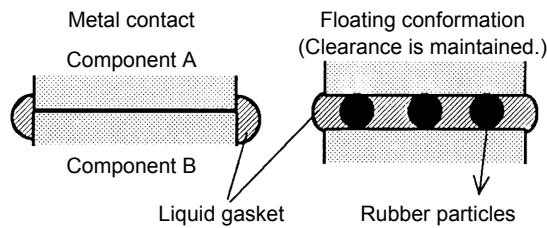

<Vibration isolating properties>

As shown in the figure below, gaskets absorb vibration energy generated between flanges. Converting vibration energy into thermal energy suppresses natural vibration and resonance and attenuates the propagation of vibration over distances.

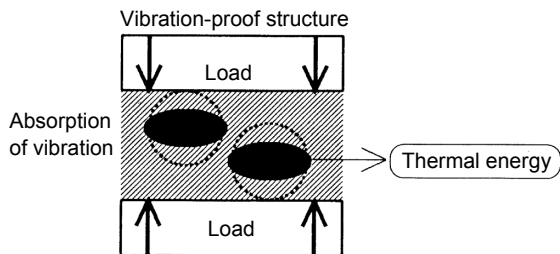

Since the gasket is a composite consisting of a liquid gasket and heterogeneous rubber particles, it has internal friction. So it is effective to block high frequency vibrations. This effect is sustained not just along the vertical direction, but horizontal direction and rotation direction, absorbing vibration energy in three dimensions. Vibration isolating characteristics can be diversified by changing the combination of liquid gaskets and rubber particles.

<Shrinkage stress>

Liquid gaskets include silicone, acryl, and synthetic rubber types, most of which shrink in volume during curing or reaction. This liquid gasket shrinkage increases stress within the sealing layer, which sometimes exceeds the adhesive property at

the joint surface, resulting in separation of the interface during the curing process. To reduce shrinkage on curing, it is effective to blend the rubber particles. The higher the ratio of volume of rubber particles for a liquid gasket, the less marked the shrinkage on curing. In the case of volatile solvent liquid gaskets, they have high shrinkage ratios on curing so that it is particularly important to reduce shrinkage on curing and relaxation of internal stress by blending rubber particles.

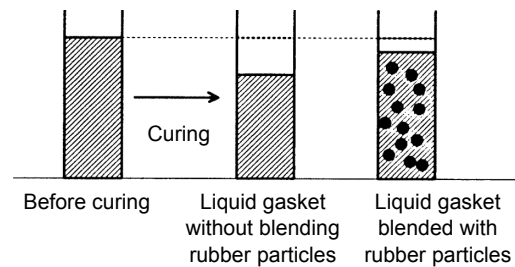

1-4 Rubber particles

The size, shape, and quality of the rubber particles added to liquid gaskets must be selected appropriately, based on the specific application and purpose.

For example, if it is important to retain a clearance at the flange face, we must select particles resistant to deformation when subjected to pressure, meaning particles of the appropriate hardness. If vibration-isolating properties are important, the material selected should have a high loss modulus (vibration absorption) in dynamic viscoelasticity. Since the loss modulus of rubber particles is highly temperature-dependent, the loss modulus in the temperatures used in real-world situations must be considered.

Above all, the critical factor is that these rubber particles are uniformly dispersed in the liquid gasket. Nonuniform dispersion will destabilize gasket properties and may result in degradation and embrittlement.

As described above, the properties of Floating Conformation OLGs are highly dependent on the mutual relationship between the rubber particles and the liquid gasket. Selecting optimum combinations of the two components should produce desirable performance across a wide range of applications.

We believe that the concept of Floating

Conformation OLGS will become the foundation of future OLGS technology, deploying various technologies within the field. We also expect its widespread deployment as an environment-friendly anti-vibration technology.

2. UV-OLGS (tentatively G-II)

2-1 Background

G-II is a liquid gasket whose viscosity rapidly increases when irradiated with UV rays after coating, producing high initial pressure resistance and adhesiveness after assembly.

Liquid gaskets based on condensation-type silicone are widely used in various fields, particularly in the automotive industry, due to their easy handling and durability. However, since liquid gaskets of this type require airborne moisture to cure, they take long curing times. Therefore they cannot be used when pressure is applied immediately after assembly. In applications that require initial pressure resistance, one response has been to increase gasket viscosity or implement other measures to accelerate curing remarkably. However, the high viscosity of the liquid gaskets in these solutions increases manufacturing difficulty, often forcing the adoption of large discharge pumps or significantly slower production lines. Additionally, significant faster curing remarkably degrades storage stability and makes it difficult to hold the adhesiveness required because curing at the surface takes place after coating is finished, before assembly is complete.

G-II solves these problems and implements low viscosity and high initial pressure resistance that conventional liquid gaskets cannot achieve.

2-2 Overview of G-II

<Characteristics>

G-II has the UV irradiation process that increases the viscosity of discharged liquid gasket, resulting in the following advantages:

- Excellent workability due to low viscosity of the discharged liquid.
- UV irradiation boosts initial pressure resistance.
- Ideal for parts with large gaps.
- Excellent adhesiveness

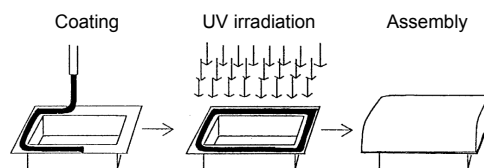

Schematic diagram of the process

These advantages enable use with parts for which conventional liquid gaskets cannot be used, while reduction of initial leakage boosts productivity.

<Reaction mechanism>

As with conventional products, the major component of G-II is a condensation-type silicone, to which UV rays curing function are added. These components stiffen with UV irradiation and are dispersed or cross-linked in a network structure in the silicone base. This increases viscosity and produces different characteristics from the material immediately after discharge. As with conventional liquid gaskets, the reaction of the silicone itself proceeds by reaction with moisture in the air.

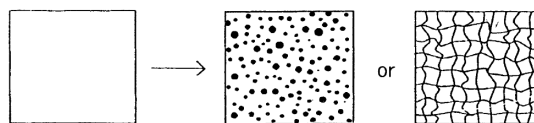

Transitional state caused by UV irradiation

<Initial pressure resistance>

Let's compare viscosity boosted with UV irradiation with the viscosity of Three Bond 1280B (hereafter abbreviated TB1280B) that is a representative of conventional high viscosity grade products.

The table of physical properties shows that the initial viscosity of G-II is lower than that of TB1280B, but with UV irradiation, initial pressure resistance increases proportionally with UV exposure.

The graph also shows that the relationship between the initial pressure resistance of TB1280B and that of G-II is reversed with the irradiation of 400 mJ/cm², with G-II indicating higher initial pressure resistance thereafter.

<Adhesiveness>

Since irradiation increases viscosity rather than solidifying the base material, G-II provides adhesiveness of equal quality to conventional products.

Shear adhesive force

	G-II	TB 1280B
Fe/Fe MPa (kgf/cm ²)	2.1 (21)	2.2 (22)
Al/Al MPa (kgf/cm ²)	2.2 (22)	2.0 (20)

The high initial pressure resistance of G-II is achieved by adding the curing effect of UV rays to

condensation-type silicone to increase viscosity. We are currently targeting rapid deployment of G-II for practical applications by developing a UV irradiation system suitable for existing production lines and by performing commercial tests using actual work pieces.

Table of physical properties

Item	Unit/condition	Measured value		Remarks
		G-II	TB1280B	
Appearance		White paste	Gray paste	
Specific gravity	at 25°C	1.05	1.07	
Viscosity	Pa•s at 20°C	55	200	SOD viscosimeter

Comparison of initial pressure resistance between G-II and TB1280B

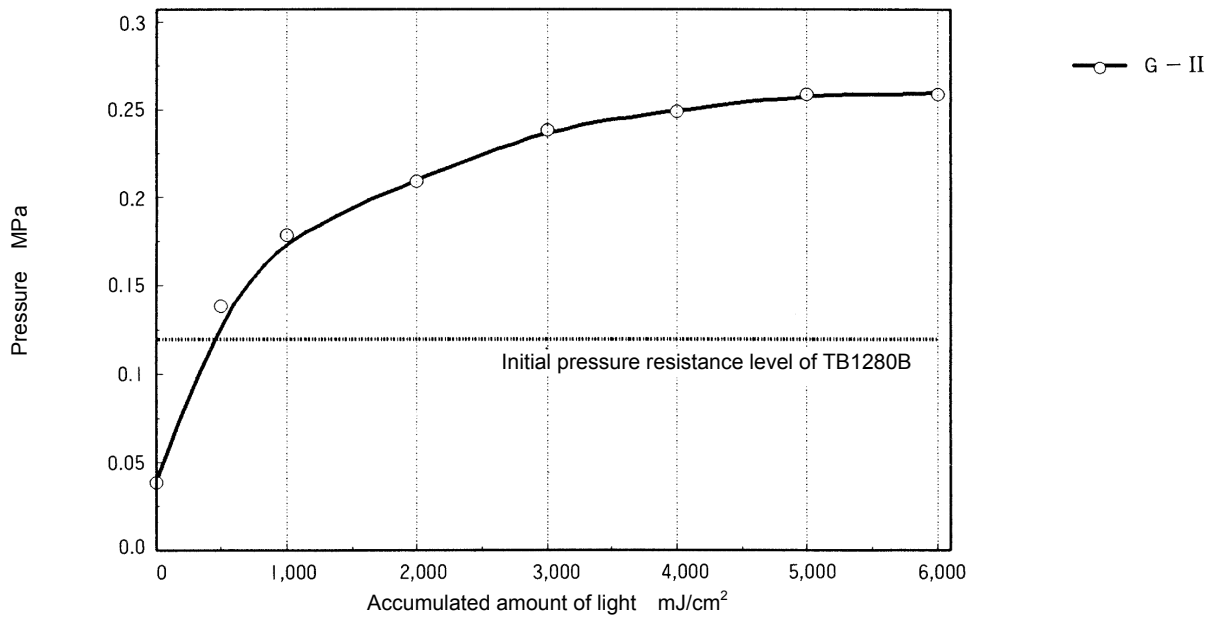

(Measuring conditions)

- Flange width: 10 mm, clearance: 0.5 mm
- Pressure rising: 0.02 MPa {0.2 kgf/cm²}/30 sec
- The indicated pressure is holding pressure (air pressure).

3. Rubber gasket provided with carrier (tentatively BECS)

3.1 Background

Three Bond previously announced the High Mold System that can automate the rubber molding gasket, and now has actively promoted the widespread use of the system. This system consists of two types: High Mold D and High Mold O. In the first type, to produce plastic moldings with injection molding, silicone rubber for injection molding is integrally molded by the double injection method. In the second type, a sealing component prepared in advance is inserted into the metal mold, producing moldings integrated with gaskets by the outsert molding method (insert molding method), using silicone rubber for injection molding. Preparing such components eliminates the need to attach gaskets on the assembly line, making it possible to mount components automatically. However, this system presents several problems. First, compatible rubber materials are limited to silicone rubber, and burrs are often generated in the metal mold while molding silicone rubber because silicone rubber is a liquid. Various steps have been taken to eliminate burrs, particularly involving metal mold structures, but this restricts the structure of the sealing components and requires the exclusive design of High Mold System components. Another problem is that the High Mold System Type D requires costly, complex molds for double injection. On the other hand, in conventional systems, some O-rings may be inserted on the production line by automatic insertion machines. However, this is possible only for O-rings with simple shapes; the problem is that O-rings are deformed by stacking when transported from rubber molding suppliers to the assembly line, preventing appropriate handling by automatic insertion machines.

BECS (Beamed Elastomer Composite System) resolves all of these problems, enabling automatic insertion of molded gaskets (also applicable to rubber products other than gaskets) that have complex shapes and are composed of various materials without redesigning existing parts. Since BECS enables simultaneous insertion of multiple gaskets, the system is expected to bring significant cost reductions. The molding technologies themselves are conventional technologies for rubber molding such as press-molding and injection molding, which can be applied to a wide range of

applications. Lastly, the molds required are inexpensive.

3-2 BECS Overview

Figure 2 shows the structure of a product molded by BECS provided with carrier. The basic concept is that a rigid carrier made of a stiff material is provided outside the deformable gasket; the carrier and gasket are then joined with a burr-like thin film, something normally avoided due to problems in the subsequent rubber forming operation. This proves to be an advantage with BECS, since the boundary between the rubber molding product and the burr-like thin film has a wedge-shape structure that is easily torn off. The rubber component required for the final product is torn off and inserted into the sealing component only by a simple press fitting operation on the assembly line. The end result is the automatic production of integrated components having shapes identical to those prepared by manual insertion.

Figure 1 shows the insertion process for BECS on the assembly line. Since the carrier is rigid, it can be transferred by robots or part feeders. Positioning is performed automatically. At this time, positioning accuracy can be improved by deploying positioning pins and by providing holes for pins in the carrier. After the BECS gasket is automatically set on the sealing component, the gasket is pressed down with a press so that the gasket is torn off from the carrier at the wedge-shaped boundary and fitted into the sealing component. Then providing the press fit jig with a cutting edge will result in easier gasket tears. Thin films inside the gasket can be removed automatically from the sealing component by providing the press jig with an evacuating mechanism. Of course, it is also possible to remove the inner film in advance or to design the metal mold structure so that no film is required inside the gasket.

BECS gaskets can be used with all conventional rubber molding methods, including press molding and injection molding; they are also compatible with all materials used in conventional molding methods. BECS gaskets require few design modifications; existing configurations can generally be applied to BECS gaskets without modification. In short, BECS gaskets are suitable for a wide range of applications with minimal investment, requiring simply the preparation of simple press metal molds. Some cases will require only the remodeling of existing rubber molds. From the view of BECS

gasket suppliers, this system eliminates time- and labor-consuming burr removal for rubber molding products; in fact, burrs are turned into an advantage, all but eliminating the need for burr removal. In addition, integrated molding with the rigid carrier enables automated ejection of products, promoting automation of the overall BECS molding process.

Any material may be used for the carrier material, as long as it is sufficiently resistant to metal mold temperatures. Metallic carriers can be used repeatedly. On the other hand, plastic carriers can be recycled and their materials reclaimed for reuse. Recycling or reclaiming carriers reduces the costs associated with BECS gaskets.

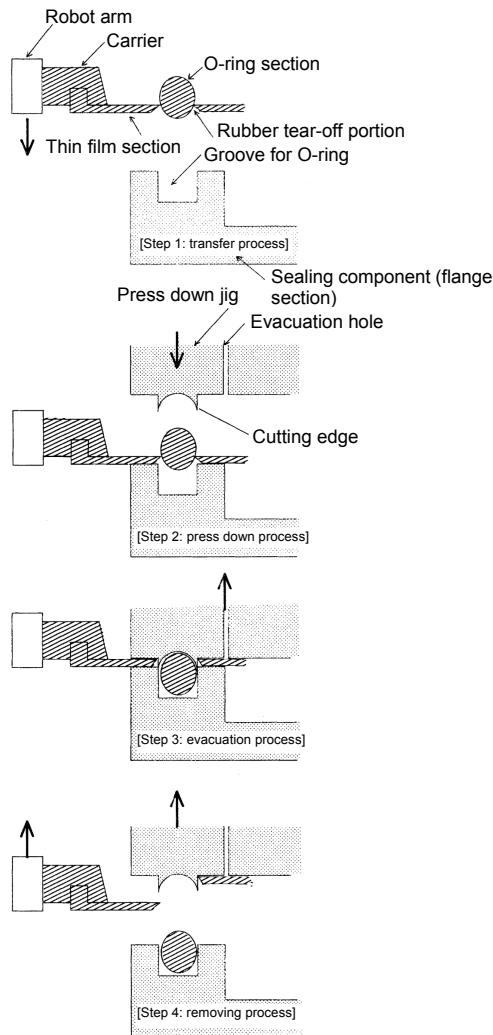

Figure 1. Insertion process for BECS on the assembly line

3-3 BECS Applications

BECS provides a very effective way to automate

processes for assembling rubber products. BECS can be used in current settings with a few or no design changes for a wide range of applications in which rubber-molding products are conventionally attached to other components. In addition to next-generation gaskets, the focus of this issue, BECS can be applied to a wide range of applications, including rubber products for vibration isolation and contact rubber (rubber switches). Given below are some examples of applications in which we can expect significant benefits.

Four or more gaskets are used at the joint between automobile engine blocks and intake manifolds. BECS will make it possible to attach these multiple gaskets in one insertion operation, reducing the number of steps required. BECS can also be applied to case component joints for waterproof portable phones, an area in which very thin gaskets of silicone rubber having thicknesses of 2 mm ϕ or less are currently used. Such gaskets are often said to be difficult to automate attaching, due to their very thin profiles. BECS is highly likely to automate the process. Outside of gaskets, silicone rubber switches are widely used in modern OA equipment and electronic musical instruments. BECS will make enable single-step assembly of such switches. BECS may also be applied to products having three-dimensional shapes such as cylinder head gaskets.

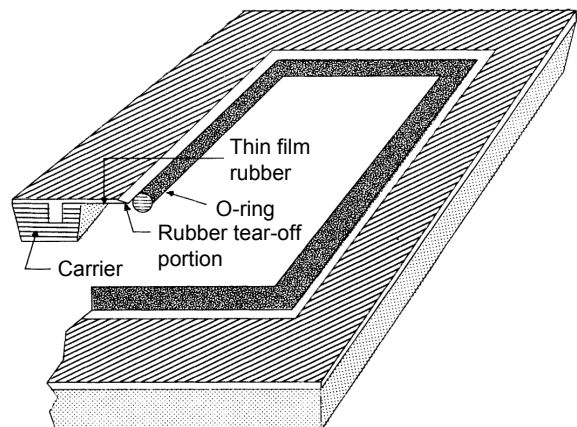

Figure 2. Basic structure of BECS gasket

Since BECS is a brand-new technology, we will pursue intensive development efforts based on customer proposals and requests. This will allow application of the technology across a wide range of fields and we contribute the automation of gasket applications.

4. Super OLGS

4-1 Background

In OLGS, a one-part condensation-type RTV silicone rubber is coated by using a robot to allow a flange face to be sealed directly on the assembly line. The method is widely used in various industries, including the automotive industry. However, the single-liquid condensation-type RTV silicone in current use cures in the presence of airborne moisture, and this curing reaction proceeds only at surfaces in contact with the atmosphere. This means the rate of curing reaction within the flange faces is very low. Product inspections (e.g., as pressure resistance tests) are often performed before curing is complete, which may result in creating potential problems. Measures taken to increase the viscosity of the sealant or reduce the time required for curing have failed to solve the problem completely.

The Super OLGS described here features an automatic coating of two-part condensation-type RTV silicone by using a robot. This system may provide one of the answers to the preceding problems by quickly curing the sealant after coating and assembly on the line.

4-2 Problems posed by conventional two-part silicone

Why can't conventional fast-curing two-part silicone be applied to OLGS? Conventional two-part silicone has the characteristics shown in Table 1. As shown in the table, condensation type silicone poses various problems involving the coating system, including coating problems of measuring and mixing arising from the wide range of possible compounding ratios and significant differences in viscosity between the base resin and curing agent. On the other hand, with addition type silicone, the issue of resin is that curing reactions can be disturbed by contaminated surfaces and oil stains. For OLGS applications, these defects are fatal.

Table 1. Characteristics of conventional two-part silicone

	Condensation type	Addition type
Advantages	Curing at ordinary temperatures. Excellent adhesiveness. There is no hardening inhibition.	No reaction by-products. No difference in viscosity between base resin and curing agent. Compounding ratio is 1:1.
Disadvantages	Large difference in viscosity between base resin and curing agent. Compounding ratio is 100:10 to 1.	Hardening inhibition Requires a heating process. Adhesive bonding is not performed at ordinary temperatures.

4-3 Characteristics of silicone for Super OLGS

We describe the composition of the silicone for Super OLGS, a new technology that improves these problems. Chemical compounds A and B that generate water through mutual reaction according to the equation given below are added to a conventional composition of one-part RTV silicone to prepare a mixture of base resin and curing agent.

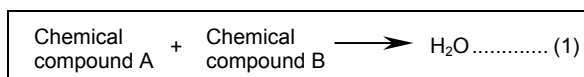

When this mixture of base resin and curing agent is mixed using a stirrer such as a static mixer, water is generated within the silicone, so that the all of the silicone can be cured uniformly without the external additional moisture. The newly developed two-part silicone has the following characteristics:

- Low rate of measuring problems
Two-part type with a compounding ratio of 1:1
Base resin and curing agent have almost equal viscosity.
- No curing interference occurs because the silicone is the condensation reaction type.
The curing reaction is not disturbed by oil stains or contaminated surfaces.
- Curing reactions take place quickly and uniformly throughout the silicone at ordinary temperatures, producing satisfactory adhesion with various adherends.
- Properties of cured material are identical to those of the conventional one-part type.
- Excellent properties are provided by mixing with stirrer such as a static mixer.

With these advantages, this system can be relatively easily applied to coating systems. A Super OLGS has arrived!

4-4 General physical properties of silicone used for Super OLGS

Table 2 shows the general physical properties of the two-part condensation-type RTV silicone used for Super OLGS 12X-258 (prototype). The table shows that the physical properties of silicone after curing are similar to those of conventional one-part RTV silicone. It is also possible to design silicone products that have the same characteristics as the conventional type, such as oil resistance and water resistance.

Figure 3 shows the change in viscosity with elapsed times after mixing the two liquids. Since viscosity increases linearly with elapsed time, initial pressure resistance is very excellent. We can expect dramatically lower rates of product defects, because the material is cured to a rubbery state in one or two hours.

4-5 Coating equipment for Super OLGS and applications

Various types of coating equipment are available for Super OLGS. The simplest are handy static

mixers, and relatively systems can be simply configured for line operations by combining a pressure feed section consisting of two piston pumps and a mixing section such as a static mixer.

Super OLGS will likely be substituted for all components by using conventional OLGS. Actual applications suitable for Super OLGS include sealants for oil pans, transmissions, differential gears, water pumps, and cylinder head covers used in automobiles. Application of Super OLGS is expected to broaden to components from which bolts are omitted, and to components in recent years formed of plastic to reduce weight, but with the side effect of degrading the accuracy of flange faces.

Super OLGS is a brand-new technology with a wide range of fields for potential applications. In addition to the preceding sealant applications, OLGS may replace the one-part RTV used for the potting of electric and electronic parts, construction sealants, and heat-resistant elastic adhesives. We plan to continue pushing forward to complete more advanced systems, incorporating proposals and requests suggested by our customers.

Table 2. Physical properties of 12X-258

Item	Unit/ condition	Measured value		
		12X-258(A/B)		TB1207D
		Liquid A	Liquid B	
Appearance		Gray paste	White paste	Silver paste
Specific gravity	at 25°	1.46	1.57	1.46
Viscosity	Pa•s at 25°C (P)	60 (600)	30(300)	250 (2500)
Tack-free time	min	8		3
Workable time	min	10		-
Hardness	JIS-A	63		62
Elongation	%	130		120
Tensile strength	MPa (kgf/cm ²)	2.4 (24.6)		3.9 (39.3)
Shearing adhesive strength Fe/Fe	MPa (kgf/cm ²)	1.6 (16.8)		1.4 (14.8)
Shearing adhesive strength Al/Al	MPa (kgf/cm ²)	1.4 (14.3)		1.2 (12.5)

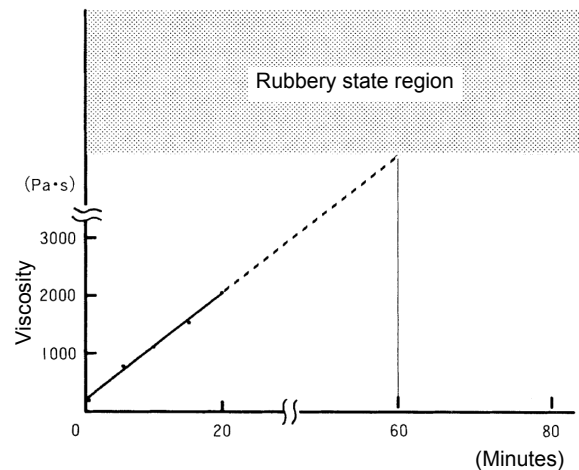

Figure 3. Change in viscosity of 12X-258 with time

5. Foaming OLGs

5-1 Background

For the gaskets used at relatively low face pressures for applications such as dust and shower seals, string-type sponge gaskets or blanked sponge gaskets are often used by fitting or pasting. Used over long periods in all fields of industry, and all working type such gaskets often require manual attachment so that their costs are hard to be lowered. Particularly in cases involving work pieces of complex shapes, the cost of the sponge material becomes very high, with the distortion and displacement of sponge gaskets during assembly leading to various problems, including process slowing and increased defect rates. Foaming OLGs was developed to resolve these problems.

Foaming OLGs is a completely new system in which special foaming silicone resin is applied by using robots to parts for which the foaming sponge was formerly used. The applied silicone is rapidly foamed and cured to form expanded silicone gaskets on the work piece. The use of Foaming OLGs can dramatically reduce the labor required to fit and attach gaskets, resulting in significant cost reductions. It also provides high potential for reducing the working space and defect rates while increasing productivity. Foaming OLGs retains the advantages of silicone material while offering excellent heat and cold resistance, compression recovery, and chemical resistance.

We believe that Foaming OLGs can substitute conventional sponge materials as dust seals, water-proofing, sound insulation, vibration isolating materials, heat insulating materials, and filling materials and it reduces costs and improves functionality.

5-2 Foaming OLGs Overview

In Foaming OLGs, foaming silicone sponge is automatically formed using a foaming silicone resin and a coating robot unit developed for this system. The system offers few indications that it uses a two-part resin.

Figure 4 shows a system overview.

The system is roughly divided into primary sections of the system are the pressure feed section, mixing section, robot section, and auxiliary facilities. Each section is the result of our proprietary expertise.

<Pressure feed section>

- Pail can pump
A pump that feeds the resin stored in a pail can to the buffer tank. The packing is made to special specifications.
- Buffer tank
Used to suppress pulsation and adjust pressure.
- Pressure feed pump
Circulating pump that provides stable discharge. Constant circulation of the material using the pump maintains the consistency of physical properties of the resin fed to the mixing head.

<Mixing head section>

- Mixing head
Developed exclusively for Foaming OLGs, this high-performance dynamic mixing head efficiently mixes the two liquids. The head design provides high stirring efficiency to make it possible to obtain dense foam cells even at relatively low rotating speeds. The resin resists gelling even when discharged continuously. The design also provides easy head cleaning.
- Chiller (cooling equipment)
The chiller removes heat generated by the motion of the mixing head to prevent resin gelation.
- Washing tank
Used to wash the mixing head. Can be operated automatically using a timer.

<Robot section>

- Two-dimensional robots, three dimensional robots, and multi-axial robots may be selected according to the nature of the work piece and purpose of the operation. The discharge nozzle is driven by tracing the coating pattern together with the mixing head. Under certain conditions, the position of the mixing head may be fixed and the work piece driven.

<Auxiliary facilities>

- Low-wavelength UV irradiation equipment
Used when adhesiveness is required. The work piece is irradiated with low-wavelength UV for several tens of seconds.
- Heating furnace
Used for preheating the work piece and for curing with foaming the resin after coating.

5-3 Resin for Foaming OLGs

The resin for Foaming OLGs cures with foaming based on the following reaction mechanism.

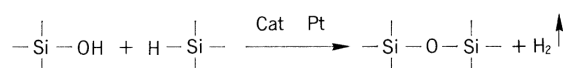

Hydrogen gas is generated with the curing reaction (elastomerization), and this hydrogen becomes the source of the foam. While it is technically possible that silicone material for Foaming OLGS produce both the open-cell type, which provides acoustic absorption properties, and the closed-cell type, which provides sealing properties, the newly introduced Three Bond 1290C and 1291C are the closed-cell type.

For the above-mentioned reaction, platinum catalysts are used to provide the following advantages: (1) 1:1 compounding ratio; (2) high curing rates; and (3) minimal odor generation. On the other hand, high reactivity generates catalytic poison.

It must be noted that the presence of sulfur compounds, organic tin compounds, or amines may disturb curing reaction with foaming.

For reference, Table 3 shows the general properties of Foaming OLGS Three Bond 1290C and 1291C.

Table 3. General properties of Three Bond 1290C and 1291C

Item		Denomination		1290C	1291C
				Base resin	Curing agent
Before curing	Appearance			White paste	Black paste
	Viscosity	Pa•s (P)		13 (130)	12 (120)
	Specific gravity			1.1	1.1
During Curing	Rise time	s		180	
	Gel time	s		300	
After curing	Hardness	Asker C		25	
	Elongation	%		110	
	Tensile strength	kPa (kgf/cm ²)		343 (3.5)	
	Expansion ratio	Ratio		2.5	
	Number of cells	Number/25 mm		140	
	Residual compressive strain	%		10	
	Air permeability	mL/s		0	
	Thermal conductivity	mW/(m•k) (kJ/(m•h•°C))		53.3 (0.21)	

5-4 Comparison of Foaming OLGS with the conventional method

Table 4 compares Foaming OLGS with the

Table 4. Comparison of Foaming OLGS and the conventional method

Item	Foaming OLGS	String-type sponge gasket	Blanked sponge gasket	Mechanical foaming with nitrogen gas	Two-part urethane resin
Automation	Possible	Not possible	Not possible	Possible	Possible
Production cycle	Short	Long	Long	Short	Relatively long
Quality stabilization	Good	Poor	Poor	Good	Good
Curing time	1 to 10 minutes	Long *1	Long *1	Long *2	10 minutes to 24 hours
Equipment cost index	100	0	0	100 to 200	150 to 200
Production space	Normal	Wide area is required.	Wide area is required.	Normal	Wide area is required.
Cost	Normal	Low	High	Normal	Normal
Adhesiveness	Good for certain materials Can adhere to almost all materials with UV irradiation	Adhesives are required.	Adhesives are required.	Poor	
Heat resistance	Good	Normal	Normal	Poor	Normal

*1 When adhesives are used.

*2 For reactive type.

conventional method. Since the string-type sponge gaskets and blanked sponge gaskets have been mentioned on the previous page, the thermoplastic elastomer (mechanical foaming with nitrogen gas) and two-part urethane resin are provided briefly.

< Thermoplastic elastomer foaming >

Nitrogen gas is injected into rubbery resin under heat to promote foaming. Compression recovery degrades during heat due to thermoplasticity, and reaction-type thermoplastic resins typically take a long time to cure.

<Two-part urethane resin foaming >

As in the case of foaming silicone, two liquids are mixed, stirred, and discharged. Resin costs less than silicone but takes longer to cure completely. This increases the length of the heat-curing line and requires more working space. The reaction starts so quickly that problems may arise in continuous production. In addition, compression recovery is poor at high temperatures, and adverse effects to environment may arise from the Freon gas or carbon dioxide gas used in the reaction.

5-5 Major applications of Foaming OLGS

Foaming OLGS is primarily used for waterproof and dustproof sealants. It is also used for sound absorption, vibration isolation, and heat insulating purposes by taking advantage of its cushioning properties. It can also be used to seal gaps in wire penetration and air ducts, and packing to attach electrical parts by using foaming pressure.

Foaming OLGS was introduced to the market in February 1993. Since optimization of each application is crucial for this technology, many considerations will be discussed. We are currently working to perfect this technology by incorporating customers' requests and suggestions.

As with our other products, we hope that our goal with Foaming OLGS is to help our customers cut costs while improving product functionality.

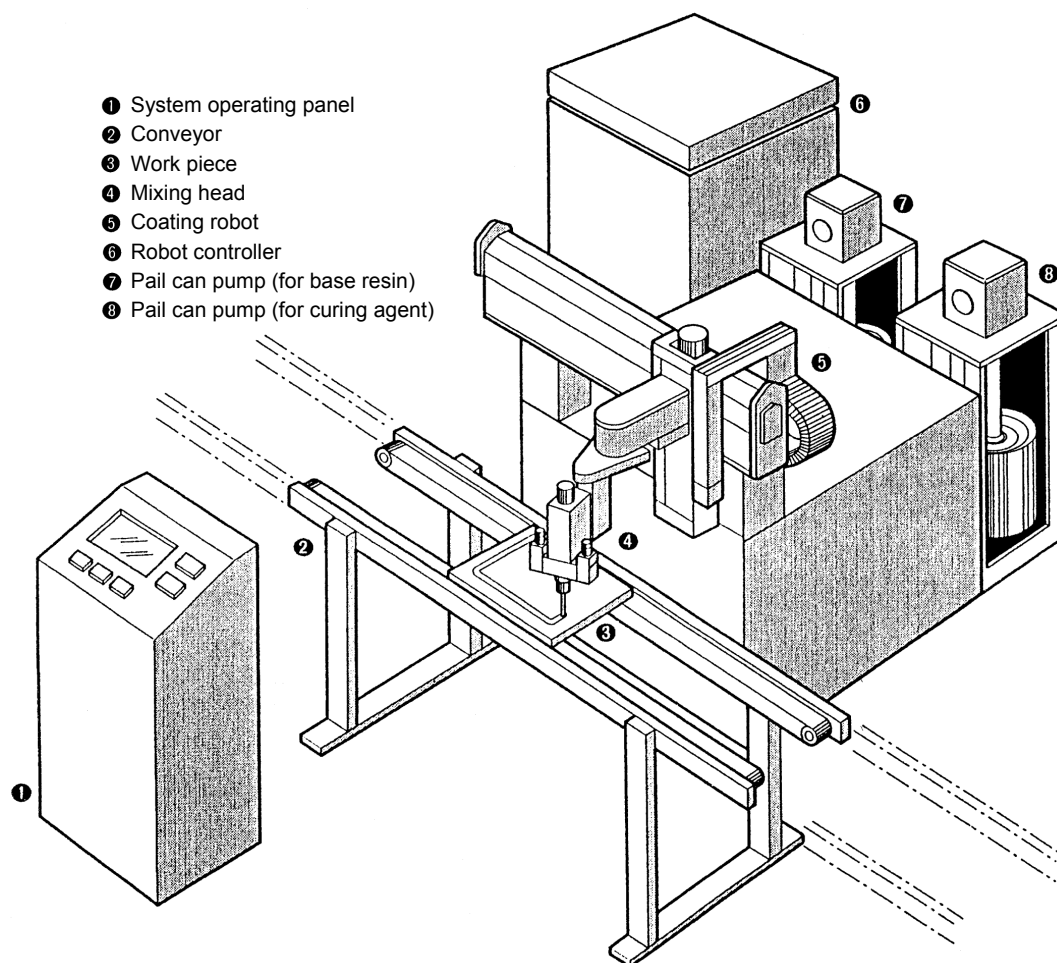

- ① System operating panel
- ② Conveyor
- ③ Work piece
- ④ Mixing head
- ⑤ Coating robot
- ⑥ Robot controller
- ⑦ Pail can pump (for base resin)
- ⑧ Pail can pump (for curing agent)

Figure 4. Foaming OLGS

Conclusion

Our goal with the preceding material is to clarify new technologies related to next-generation gaskets and concepts. At all times, our mission is to help our customers reduce labor requirements and costs and rationalize production lines by making full use of new technologies. We seek to do this by paying close attention to customers' opinions and requests. It is our pledge to meet your expectations within the earliest possible timeframe permitted by product development cycles.

Nobuhiro Katsuno
 Functional Material Research Department
 Kazuyuki Chiba
 Custom M Group
 Yasuo Hanazuka
 Custom M Group
 Kunihiko Nakajima
 Chemical Mechatronics Group 1
 Kazuhiro Kojima
 Custom E Group
 R&D Laboratory
 Three Bond Co., Ltd.

