

ThreeBond TECHNICAL NEWS

ThreeBond Technical News
Issued: June 23, 1992

38

Water-Based Pressure-Sensitive Adhesives for Screen Printing

Introduction

Pressure-sensitive adhesives are part of our everyday lives, but most people know surprisingly little about what they actually are. This paper attempts to provide information on pressure-sensitive adhesives for screen printing in plain words for the ordinary reader. We hope reading this paper will deepen your understanding of pressure-sensitive adhesives.

Contents

Introduction	1
1. Pressure-Sensitive Adhesives.....	2
1-1. Types of Pressure-Sensitive Adhesives	2
1-2. Test Methods for Pressure-Sensitive Adhesives	3
2. Aqueous Solutions and Emulsions.....	5
2-1. Emulsions	5
2-2. Types of Emulsions	6
2-3. Structure of Emulsions	6
2-4. Emulsion Particles	7
2-5. Production Methods for Emulsions.....	7
3. Screen Printing.....	8
3-1. Principle of Screen Printing	8
3-2. Types of Screens.....	8
3-3. Relationship between Screen and Film Thickness.....	9
4. Pressure-Sensitive Adhesives for Screen Printing.....	10
4-1. Viscosity Characteristics.....	10
4-2. Leveling and Defoaming Properties	10
4-3. Thixotropy (Thixotropic Property)	10
4-4. Drying Characteristics	10
5. Water-Based Pressure-Sensitive Adhesives from ThreeBond.....	11
Conclusion	12

1. Pressure-Sensitive Adhesives

We hear the term “pressure-sensitive adhesion” fairly often. Conceptually, this refers to a material that feels sticky to the touch. Pressure-sensitive adhesion is defined as follows: “a type of adhesion wherein the bond is temporary. In common usage, it may refer to permanent adhesion. Pressure-sensitive adhesives do not employ water, solvent, or heat. Modest pressure applied for a short period of time at room temperatures is required to produce a bond. While pressure-sensitive adhesives form strong bonds due to their cohesive strength and elasticity, they are readily peeled from hard, smooth surfaces. The application of additional post-treatment can turn the bond into a permanent one (JIS Z 0109).”

According to this definition, “pressure-sensitive adhesion” is a type of “adhesion.” However, in practice, it’s hard to distinguish between the two, since some adhesives have “pressure-sensitive adhesive properties” for a brief period. One example is the rubber system adhesive used to repair punctured bicycle tires. Before application, when it is not fully dry, it is sticky. When dried, rubber system adhesives lose their sticky PSA properties.

Other substances classified as adhesives retain their stickiness permanently, while others ultimately lose or demonstrate reduced stickiness.

We will distinguish between these adhesives by referring to adhesives that remain permanently sticky as pressure-sensitive adhesives (PSA). The Japanese term is a direct translation from the English counterpart. From here on, we will use the term pressure-sensitive adhesives (PSA).

1-1. Types of Pressure-Sensitive Adhesives

Pressure-sensitive adhesives can be classified by the type of ingredients used to make them (e.g., rubber-based, acrylic, silicone) and by their state (e.g., organic solvent solution, emulsion, solid (hot melt) and aqueous solution).

With respect to performance, the characteristics of PSA are generally determined by their ingredients. The insert to the right gives a brief summary based on ingredient type.

The main applications are as follows:

- Temporary bonding (re-bonding not required; easy removal preferred)
- Bonding “hard to bond” adherends (e.g., PP, PE, PTFE, and EPDM)
- Temporary bonds (e.g., adhesive processing of nameplates, adhesive coatings on labels, films)

Natural rubber-based pressure-sensitive adhesives

- Natural rubber
Crosslinked to enhance cohesive strength
- SBR
Used in combination with natural rubber, since a small volume of tackifier additive adhesive can enhance strength
- Reclaimed rubber
Used to coat calendar surfaces due to its partially vulcanized properties
- Polyisobutylene
A blend of high and low molecular weight resins; made by partial crosslinking of butyl rubber and addition of fillers
- Block copolymer
Readily plasticized by heat through the formation of styrene domains; representative examples include SIS and SBS.

Acrylic pressure-sensitive adhesives

- Crosslinked
A monomer with low glass transition temperatures is crosslinked by blending a crosslinking agent.
- Non-crosslinked
Monomers having low and high glass transition temperatures are copolymerized to produce a pressure-sensitive adhesive.
- Water-soluble
Monomers having carboxyl groups are copolymerized, after which alcohols and polyethylene oxide are added.



Silicone pressure-sensitive adhesives









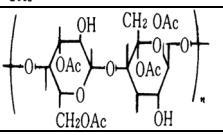





- A blend of silicone rubber (high cohesive strength) and silicone resin (high adhesive strength)

- Primary processing of adhesive components (e.g., double-sided adhesive tape)
- Repeated peeling and adhesion (requiring enhanced re-adhesion and peeling properties)
It’s important to select the appropriate type of PSA for your needs.

In addition to the types above, a new type of PSA called curable PSA has appeared on the market. The product forms a temporary bond (pressure-sensitive adhesion) that later hardens through a curing reaction.

Table 1. Physical properties of polymers used to produce pressure-sensitive adhesives

Properties Polymer name	Chemical formulas (structural formulas)	SP value	Glass transition temperature (°C)	Melting point (°C)
Natural rubber	$\text{-(CH}_2\text{-C(CH}_3\text{)=CH-CH}_2\text{)}_n\text{-}$	7.9~8.3	-65~-75	
Styrene-butadiene rubber	$\text{-(CH}_2\text{-CH=CH-CH}_2\text{)}_x\text{-(CH}_2\text{-CH)}_y\text{-}$ 	8.1~8.5		
Silicon rubber	$\text{-(Si(CH}_3\text{)}_2\text{-O)}_n\text{-}$	7.3~7.5	-123	
Chloroprene rubber	$\text{-(CH}_2\text{-C(CH}_2\text{)=CH-CH}_2\text{)}_n\text{-}$ 	9.2~9.4	-50	40~43
Butyl rubber	$\text{-(C(CH}_3\text{)}_2\text{-CH}_2\text{-C(CH}_3\text{)=CH-CH}_2\text{)}_n\text{-}$ 	7.7		
Acetate		10.9	120	220
Polyacrylate	$\text{-(CH}_2\text{-CH(COOH))}_n\text{-}$		80~95	
Ethyl polyacrylate	$\text{-(CH}_2\text{-CH(COOC}_2\text{H}_5\text{))}_n\text{-}$		(-23~-29)	
Butyl polyacrylate	$\text{-(CH}_2\text{-CH(COOC}_4\text{H}_9\text{))}_n\text{-}$		-57(-56)	
Propyl polyacrylate	$\text{-(CH}_2\text{-CH(COOC}_3\text{H}_7\text{))}_n\text{-}$		-40(-44)	
Methyl polyacrylate	$\text{-(CH}_2\text{-CH(COOCH}_3\text{))}_n\text{-}$		3	
Polyacrylonitrile	$\text{-(CH}_2\text{-CH(CN))}_n\text{-}$		80~100 (104~130)	

Properties Polymer name	Chemical formulas (structural formulas)	SP value	Glass transition temperature (°C)	Melting point (°C)
Polyisobutylene	$\text{-(C(CH}_3\text{)}_2\text{-CH}_2\text{)}_n\text{-}$ 	7.8~8.0	-65~-77 (-60~-70)	44
Polyethylene	$\text{-(CH}_2\text{-CH}_2\text{)}_n\text{-}$	7.9~8.1	-21~-24 (-68)	
Polyethylene terephthalate	$\text{-(CH}_2\text{)}_2\text{-O-CO-C}_6\text{H}_4\text{-CO-O}_n\text{-}$ 	10.7	6.7~6.9 (Amorphous form) 81 (Crystalline form)	
Poly vinylidene chloride	$\text{-(CH}_2\text{-C(CH}_2\text{)}_n\text{-}$  	12.2	-18 (-17)	190
Polyvinyl chloride	$\text{-(CH}_2\text{-CH)}_n\text{-}$ 	9.5~9.7	70~80 (87)	
Polyvinyl acetate	$\text{-(CH}_2\text{-CH)}_n\text{-}$ 	9.4	28~31	
Polystyrene	$\text{-(CH}_2\text{-CH)}_n\text{-}$ 	8.6~9.2	80~100	
Polycarbonate	$\text{-(O-C}_6\text{H}_4\text{-C(CH}_3\text{)}_2\text{-O-C)}_n\text{-}$    	9.7	150	220 267
Polyvinyl isobutyl ether	$\text{-(CH}_2\text{-CH)}_n\text{-}$ 		-20 (-24)	115
Polybutadiene	$\text{-(CH}_2\text{-CH=CH-CH}_2\text{)}_n\text{-}$	8.1	-120(1.4) -45(1.2)	
Polypropylene	$\text{-(CH}_2\text{-CH(CH}_3\text{))}_n\text{-}$ 	7.8~8.0	-35 (-10~-18)	
Polypropylene oxide	$\text{-(CH}_2\text{-CH}_2\text{-O)}_n\text{-}$ 	7.5		

1-2. Test Methods for Pressure-Sensitive Adhesives

Pressure-sensitive adhesives are normally evaluated based on their “peeling” properties. As shown in Fig. 1, the forces acting on the adhesive layer during peeling consist of the adhesive forces at the boundary between the adhesive agent and adherend, the cohesive force of the adhesive layer, and the elongation of the backing (e.g., films). Due to the complex behavior of these components, evaluation testing for adhesives is generally divided into three test types: for adhesive strength (peeling strength), cohesive strength, and tackiness (initial pressure-sensitive adhesive strength). These three are sometimes called the three elements of pressure-sensitive adhesion. Pressure-sensitive adhesive strength is primarily determined by these three factors.

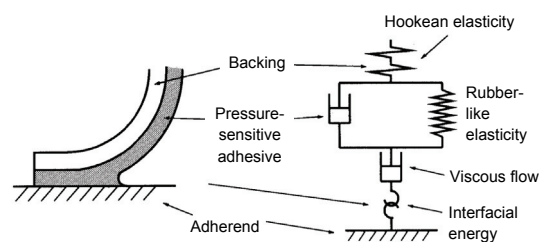

Figure 1. Mechanical model for peeling of adhesive tape

- 1) The strength of a PSA is generally indicated by its peeling strength. The term pressure-sensitive adhesive strength generally refers to peeling strength; the term adhesive strength as used in this section can be read to mean pressure-sensitive adhesive strength in the strict sense.

As shown in Figs. 2 and 3, peeling strength is measured by the force required to peel adhesive tape from an adherend at either 90° or 180° angles. The adhesive tape or film to which the adhesive has been applied is removed at a constant tension and speed. JIS specifies two different speeds: The first, 200 mm/min., is for a method for evaluating the peeling strength of adhesives (JIS K 6854); the second, 300 mm/min., is for a method for testing adhesive tapes and adhesive sheets (JIS Z 0237). Note that different manufacturers may adopt different speeds for their own testing.

In the past, the basic width of the tape/film for the peeling strength test was set to 25 mm (1 inch). The results were represented in units of kgf/25 mm. However, due to the adoption of the SI unit for the peeling strength test in recent years, results are now more often given in units of N/m.

- 2) Cohesion Strength (also known as holding strength) refers to the hardness of the PSA layer. As shown in Fig. 4, the test for PSA cohesion involves measuring the shift in position of a tape/film attached to a steel plate pulled down by a weight at a fixed temperature (normally 40°C).

For example, a test of a double-sided adhesive tape gives the results of measurement at 40°C after the tape is subjected to a load of 1 kgf for 1 hour.

- 3) Tackiness (initial PSA strength) is often confused with PSA strength. Tackiness refers to stickiness and represents the perceived stickiness of an adhesive layer upon touch. Since tackiness refers to perceived stickiness, there are no standards for its numerical representation. Various tests are used to assess tackiness, including the thumb tack test, prove tack test, loop tack test, quick stick test, and ball tack test. The ball tack test (Fig. 5) is relatively common. In this test, a steel ball is rolled down an inclined plane, and the number of the ball (corresponding to the width of the ball) stopped within the range of the adhesive surface is used to represent tackiness. (A larger ball number corresponds to stronger tackiness.)

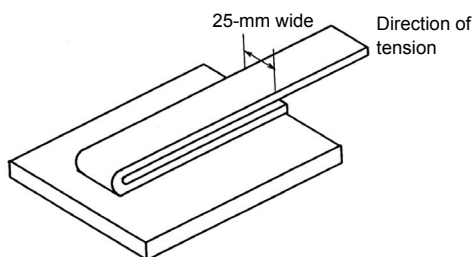

Figure 2. 180° peeling

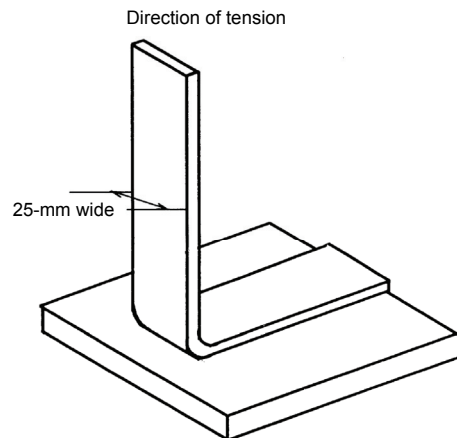

Figure 3. 90° peeling

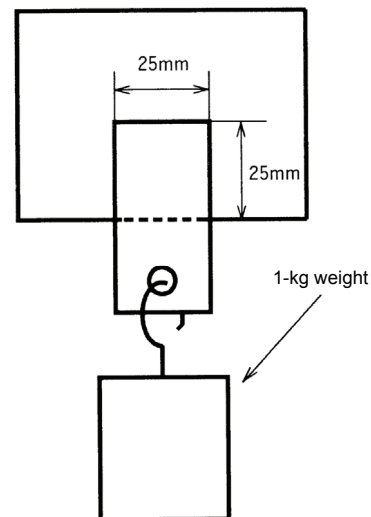

Figure 4. Measurement scheme for holding strength

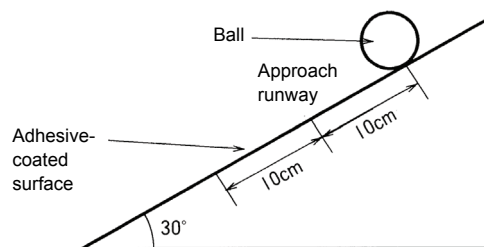

Figure 5. Ball tack test

Ball-tack test: A steel ball is allowed to roll down an inclined plane. The nominal diameter (in inches) of the ball stopped within a specified length of the adhesive-coated surface is multiplied by 32 to obtain the value for tackiness. Adhesives recording higher values have stronger tack.

2. Aqueous Solutions and Emulsions

Aqueous or water-based adhesives and paints can generally be classified into aqueous solutions and emulsions.

Aqueous solution types have water as their solvent (medium for dissolving other ingredients) and resin as the solute. Polyvinyl alcohols and methyl cellulose are representative examples of this type. Some more common examples include starch solution and gum arabic (the glue on the reverse side of stamps). Generally, aqueous adhesives dissolve readily in water or alcohol, even after they have dried.

In contrast, emulsion-type adhesives use water as the dispersion medium (medium for dispersing other ingredients), and the resin is dispersed as particles rather than dissolved in water. The resin used in emulsion-type adhesives are not water soluble, since that would make it impossible to disperse it as particles in the water. Thus, the resin film formed after the emulsion has dried is insoluble in water. (The reason such emulsion films, which should be insoluble in water, are susceptible to humidity, is explained further below.)

Our PSA products are all emulsion-types. The following sections address emulsion PSAs.

2-1. Emulsions

Readers may be unfamiliar with the word “emulsion.”

Emulsions have various names, including common ones like latex and dispersions (solutions). Emulsions are suspensions in which two normally immiscible liquids are mixed. In an emulsion, liquids having contrasting diffraction indices are dispersed among one another as fine micron-order particulates. Thus, light is reflected diffusively by the emulsion, giving it a white appearance. Emulsions on the order of 50 nm are called microemulsions (the product name may sometimes refer to a colloidal dispersion).

Colloids refer to a state in which various substances are stably dispersed among one another.

Colloids are classified by the type of phase, dispersed or continuous, such as liquids dispersed in solids, gases in liquids, or liquids in gases. Among these are colloids with solids dispersed in a liquid phase (suspension) and liquids dispersed in a liquid phase (emulsion).

The words latex and dispersion were presented at the beginning of this section. In general, latex refers to a rubber emulsion. While some prefer to distinguish between the terms latex and emulsion, others use the term latex to include synthetic resin emulsions. Dispersion is simply another word for emulsion. Hereafter, we use the term emulsion in the collective sense.

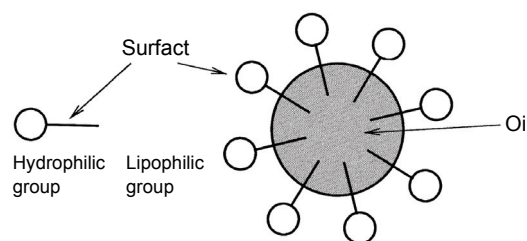

Figure 6. Schematic diagram of emulsion particles

Table 2. Comparison of emulsion particle diameters

Name	Diameter
Surfactant spherical micelles	35 ~ 150 Å
Microemulsions	10 ~ 100 nm
Unilamellar liposomes	25 ~ 30 nm
Multilamellar liposomes	0.2 ~ 1.0 μm
Emulsions	0.2 ~ 50 μm
Microcapsules	1 ~ 300 μm
Human erythrocyte	7 ~ 10 μm
Human leucocyte	10 ~ 18 μm

Table 3. Dispersion of colloidal systems

Dispersion medium	Dispersed phase	Abbreviation	Suspension system	Deposition system
Gas phase	Liquid phase	Liquid/Gas (L/G)	Fog	--
	Solid phase	Solid/Gas (S/G)	Smoke } (aerosols)	
Liquid phase	Gas phase	Gas/Liquid (G/L)	Air bubbles	Foam
	Liquid phase	Liquid/Liquid (L/L)	Emulsion	Cream
	Solid phase	Solid/Liquid (S/L)	Suspension Sol	Gel (gelatinous deposition, gelatin)
Solid phase	Gas phase	Gas/Solid (G/S)	} Solid colloids (colored glass, jewels)	} Solid colloids (e.g., porous body, xerogel)
	Liquid phase	Liquid/Solid (L/S)		
	Solid phase	Solid/Solid (S/S)		

2-2. Types of Emulsions

As stated in the previous section, an emulsion is a state in which a liquid exists stably in another liquid. Milk and butter are examples of emulsions that readers are most likely familiar with.

“Milk” is a typical example of an emulsion in which milk fat is suspended within an aqueous phase.

It may be a bit harder to imagine “butter” as an emulsion.

Butter is made by removing water from milk. It consists mainly of milk fat. However, butter still retains a certain amount of water. The evidence for this is the moisture found on the knife when butter is cut.

Even though butter appears to be free of water, water is dispersed throughout butter. This is the state opposite of milk, in which milk fat is dispersed in water. Thus, butter is also an emulsion.

Emulsions in which particles of oil are dispersed in water, like milk, are called O/W emulsions. Those in which water particles are dispersed in oil, as in butter, are called W/O emulsions.

Hereafter in this paper, the term “emulsion” refers to O/W emulsions unless specifically stated otherwise.

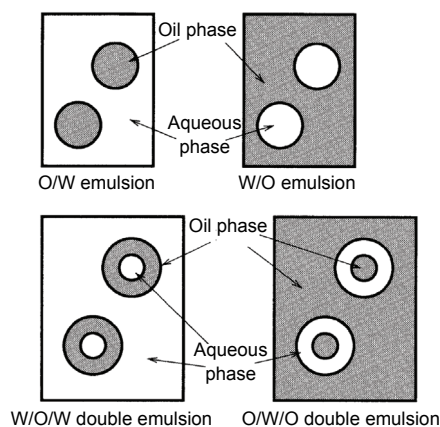

Figure 7. Types of Emulsions

2-3. Structure of Emulsions

When water and oil are simply mixed, the oil rises to the surface of the water. However, in an emulsion, the same combination exists stably in a mixed condition. The secret is in the surfactant added to the emulsion.

Figure 6 shows the structure of a mixture that has become an emulsion. Emulsions basically consist of three components: water, resin, and surfactant.

A surfactant is a substance having both hydrophilic and lipophilic groups in a single

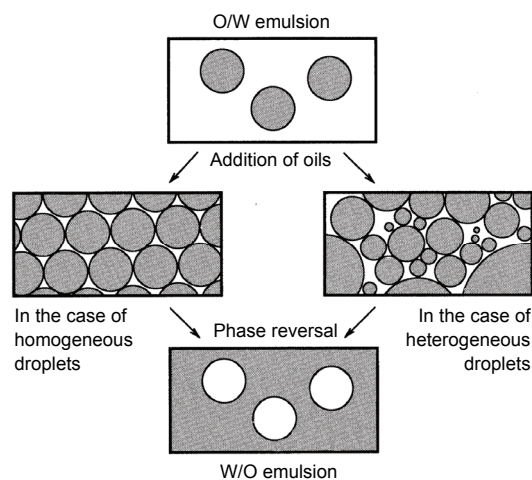

Figure 8. Phase reversal of emulsion

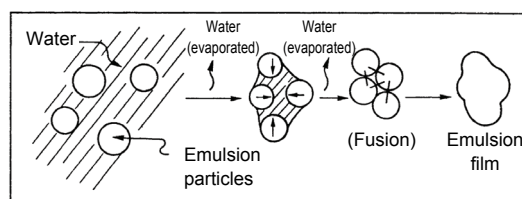

Figure 9. Film formation in emulsions

molecule. The lipophilic group points towards the oil and the hydrophilic group towards the water. In this way, the oil droplets are enveloped inside the surfactant molecules, preventing oil/water separation and forming an emulsion. (Examples of surfactants from daily life include soaps and detergents.) Surfactants used to create emulsions are often specifically called emulsifiers.

The concentrations of resins (normally shown as non-volatile components) are generally around 50%, rising as high as 70%. These values are percentages calculated from the close-pack structure of resin particles. Phase reversal (O/W into W/O) occurs at concentrations above these values, assuming constant particle diameters.

Emulsions are easier to handle than are other solvent system adhesives, since an increase in resin concentration and/or polymerization has no effect on viscosity. This phenomenon has been harnessed to create various unique commercial products. The emulsion particles in some recent commercial products have core/shell structures (Fig. 7).

2-4. Emulsion Particles

Due to surfactants, electrostatic repulsive forces act between individual particles suspended in an emulsion. This repulsion prevents the particles from fusing. This appears to contradict an earlier statement—that emulsions are stable. Emulsions are indeed stable, but breaking down an emulsion is relatively simple.

Breaking down an emulsion refers to a state in which the emulsion particles come into contact with one another and the resin fuses.

The optimal method for using emulsion adhesives is to allow the formation of a film through the evaporation of water. This is the ideal state of emulsion breakdown. The mechanism is shown in Fig. 9.

During this process, the surfactant remains with the resin, since it is not volatile. In high-humidity atmospheres, water is absorbed once again by the resin layer. This is why resin emulsion adhesives are less resistant to humidity than solvent-type resin adhesives.

Drying removes the dispersing medium—in this case water—and reduces the distance between particles in the emulsion, eventually moving them into contact with one another. The same effect can be achieved by eliminating the repulsive force created by the surfactant.

The surfactants used in emulsions are generally mixed systems of either anionic or cationic surfactants. The different types of surfactants are shown in Table 4. The anionic surfactants are stable in aqueous solutions under alkaline conditions. Most emulsions exhibit alkalinity in the range from pH 7 to 11.

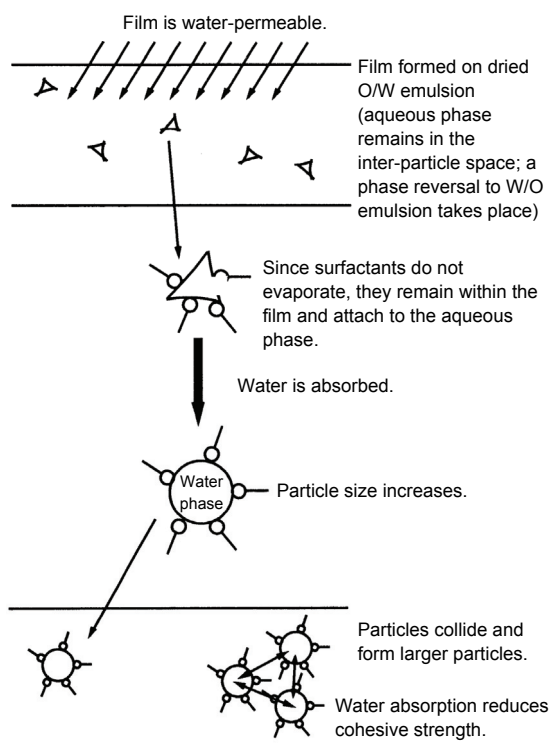

Figure 10. Mechanism of water absorption by film

Table 4. Types of surfactants

- © Ionic surfactants
 - a) Anionic (negative ion) surfactants
 - Carboxylate
 - Fatty acid soaps
 - Amino acid salts
 - Sulfonate
 - Alkyl benzene sulfonate
 - Sulfuric acid ester salts
 - Phosphoric acid ester salts
 - b) Cationic (positive ion) surfactants
 - Amine salts
 - Quaternary ammonium salt
 - c) Amphoteric surfactants (exhibit both anionic and cationic dissociations within a single molecule)
 - Aminocarboxylic acid
 - Carboxy betaine
 - Sulphobetaine
- © Nonionic surfactants
 - a) Polyoxyethylene (POE) types
 - Polyoxyethylene alkyl ether
 - Polyethylene glycol esters of fatty acids
 - b) Polyhydroxy alcohol types
 - Glycerin fatty acid ester
- © Others
 - a) Polymer surfactants
 - Polyvinylpyridine derivatives
 - POE/polyoxypropylene block copolymers
 - b) Natural surfactants
 - Bile acid
 - Cholic acid
 - Glycerophosphoric acid
 - Lecithin
 - Saponin
 - Aescin, digitoxin

When we add water or acidic substances to such emulsions, the repulsive force created by the surfactants, which had kept particles in the emulsion separated, is lost. The particles fuse, creating insoluble resin lumps.

The repulsive force between emulsion particles may also be mechanically destroyed.

In these cases, mechanical forces, such as shear or compressive force, can deform or break down the particle structure and cause fusion. Emulsions with poor mechanical stability are unsuitable for applications that involve high-speed mixing or spray coating.

2-5. Production Methods for Emulsions

There are two general emulsion production methods.

In the first, resin is dissolved in solvents to create a resin solution, which is then placed into the water to create an emulsion.

In the second, monomers, ingredients of the resin, are placed in water to be polymerized and form the resin (emulsion polymerization).

With the latter method of emulsion polymerization, the properties of the resulting resin are highly dependent on polymerization conditions. The characteristics of the finished product are unique to each emulsion manufacturer.

3. Screen Printing

Screen printing is a common printing process, said to originate from cloth printing technologies using paper patterns in ancient times. The use of paper patterns allowed the mass production of cloth of the same patterns. However, with paper patterns, it was not possible to place patterns inside an area that had been punched out. If such patterns were required, the paper pattern for the interior was attached to the outer paper by threads. In the modern era, this evolved into the technology of silk screening, in which patterns are stenciled onto a silk mesh. This technology lets us print intricate patterns with sharply-defined edges.

Screen printing has the following characteristics lacked by other printing methods:

1) We can deposit a thick ink layer

With other printing methods, the ink layer cannot exceed a thickness of several micrometers. Screen printing allows ink layers measuring 30-100 μm in thickness. (As described further below, this is especially important for printing PSA.)

2) Screen printing requires no rollers

The only parts of the screen printing apparatus with which the ink actually comes into contact with are the screen, squeegee (rubber blade used to push the ink through the screen), and the scraper (blade for leveling off ink). This allows greater freedom in applying ink than other printing methods, which use rollers. It allows expansion of the range of possible adherend materials and forms. For example, screen printing allows printing onto fragile objects (like glass) and curved surfaces (like cups and bottles).

3-1. Principle of Screen Printing

Screen printing starts with stretching a piece of screen (mesh) over a frame and securing it into place. Next, a photoreactive emulsion (a resin that cures when light is irradiated onto it) is applied to the mesh. The desired pattern is then placed onto the emulsion-coated mesh. The emulsion used to form a resist (sealant) is exposed to light. The screen is washed to remove the unhardened emulsion, and the pattern emerges as an opening not covered by the resin. We can use this as the plate for screen printing. To print, ink is placed inside the frame, and the plate is placed over the substrate to be printed. The ink is pushed out of the opening with the linear pressure from the squeegee, and the pattern is transcribed onto the substrate. This transcription process can be repeated over and over to mass produce substrates with the same pattern.

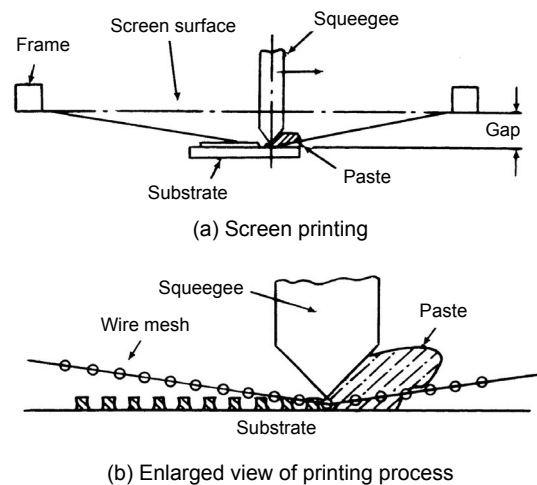

Figure 11. Screen printing

3-2. Types of Screens

Screens used in screen printing are generally classified by the materials used for the mesh and by mesh size.

1) Mesh material

Stainless steel, nylon (polyamide fibers), and Tetoron[®] (polyethylene terephthalate, polyester fiber) are the most commonly used materials for the screen mesh. All materials have their advantages and shortcomings. Select the materials that best suit your needs.

- Stainless steel

Stainless steel resists changes in temperature and humidity. However, its stability is modest compared to both nylon and Tetoron[®], and the clearance must be set to a specific minimum value to ensure precision.

- Nylon (polyamide fibers)

Nylon shrinks to an extent that varies significantly with humidity and temperatures, making it unsuitable for applications that require high dimensional precision. However, the fine fiber diameter of nylon permits large open area ratios that facilitate ink permeation.

- Tetoron[®] (polyester fiber)

Tetoron[®] offers high precision, but its large fiber diameter (compared to nylon) restricts the open area ratio.

2) Mesh size

Mesh size refers to the count of mesh openings per inch. Higher values correspond to finer mesh and higher-resolution patterns.

3-3. Relationship between Screen and Film Thickness

The previous section introduced the concept of the open area ratio. Here, let's calculate the open area ratio from mesh size and fiber material diameter (wire diameter). (Assume here that 1 inch = 25.4 mm.)

Take the case where 508 mesh has wire diameter of 25 μm (plate thickness 50 μm).

The size of a single mesh spacing is:

$$25.4 \div 508 = 0.05 \text{ mm.}$$

Thus, a single opening size is:

$$0.05 - 0.025 = 0.025 \text{ mm.}$$

The area of a single opening is $0.025 \times 0.025 \text{ mm}^2$. Since there are 508 openings along 1 inch of mesh, there are 508×508 openings within a 1-inch square. Thus, the total area of all openings within a 1-inch square is:

$$0.025 \times 0.025 \times 508 \times 508 = 161.29 \text{ mm}^2.$$

To calculate the open area ratio, we divide this value by the area of a 1-inch square:

$$161.29 \div (25.4 \times 25.4) = 0.25.$$

We obtain an open area ratio of 25% for this mesh.

We can also calculate ink thickness as open area ratio \times plate thickness. (This value corresponds to the volume of ink deposited onto the substrate.)

Since the plate thickness in the above example is 50 μm, the ink thickness is

$$50 \times 0.25 = 12.5 \text{ μm.}$$

Thus, the thickness of the ink layer is 12.5 μm. This value represents the thickness of ink before drying. To calculate the thickness of the ink after drying, we need to consider the concentration of non-volatile components.

If we assume here that the non-volatile components in this ink are 20%, the thickness after drying will be 2.5 μm.

For actual applications, the thickness of the ink layer also depends on the shape of the openings and patterns. Still, this value serves as a guide in determining the mesh size required to achieve a desired ink thickness.

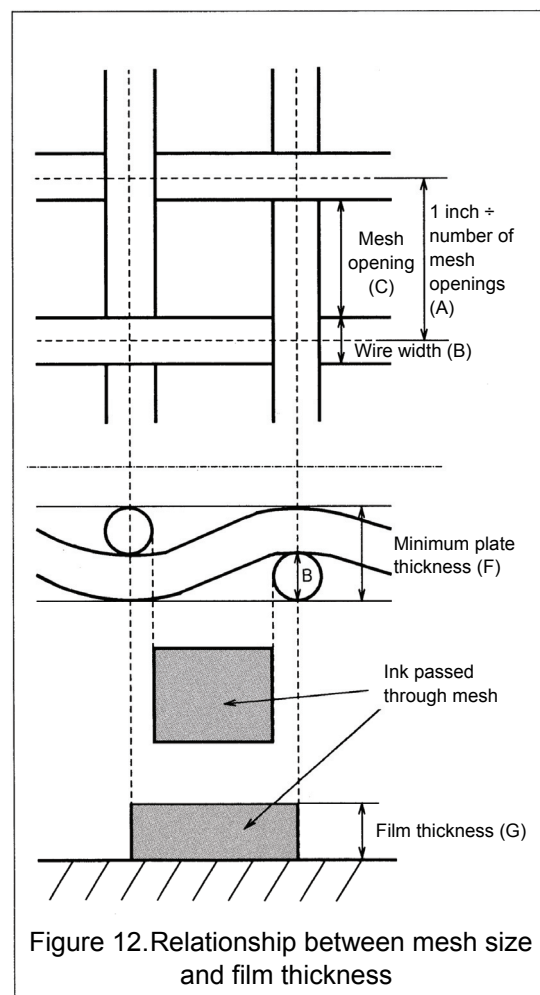

Table 5. Relationship between mesh size and film thickness

Mesh size [mm]			60	80	100	120	150	
1 inch \div number of mesh openings	[mm]	A	0.423	0.318	0.254	0.212	0.169	
Wire width	[mm]	B	0.150	0.120	0.100	0.080	0.070	
Size of opening	A-B	C	0.273	0.198	0.154	0.132	0.099	
Surface area of opening	C ² \times number of mesh	[mm ²]	D	268.9	249.6	237.2	249.8	221.9
Open area ratio	D \div (1 inch) ²	[%]	E	41.7	38.7	36.8	38.7	34.4
Minimum plate thickness	Wire width \times 2	F	0.300	0.240	0.200	0.160	0.140	
Film thickness	E \times F	[mm]	G	0.125	0.093	0.074	0.062	0.048

Film thickness in the above table is calculated based on the assumption that the film is composed of 100% resin. If the film retains solvent or water, we have to consider the volume of evaporated solvent to calculate the thickness of the film after evaporation. For example, in the case in which the film has 50% resin, the thickness will be $0.5 \times$ film thickness (G).

4. Pressure-Sensitive Adhesives for Screen Printing

In general, there are two types of adhesive coating processes: dot application using adhesive dispensers and pin transfer applicator and surface application using rollers.

However, since PSAs retain their stickiness over time, we need a coating technology that eliminates adhesive protrusion.

Adhesives are applied using screen printing technology by the same method as in ink screen printing. However, with PSAs, the adhesive layer deposited on the adherend must have a certain thickness to provide sufficient stress relaxation capacity for peeling. When applying adhesives by screen printing, we can adjust the thickness of the adhesive layer by changing the mesh size.

The screens also allow us to apply adhesives just to the areas where they are needed.

The more complex the adherend shape, the more advantageous screen printing will be compared to double-sided adhesive tapes. For example, panels that have numerous openings (windows for switches and indicators) require high positioning precision. This is especially true for adhesive coatings of membrane switches and touch panels that have curved surfaces—an increasingly common application in recent years. Adhesive application for such surfaces is extremely difficult by conventional methods, and the expectations for adhesive screen printing in these areas are quite rigorous.

To take full advantage of the superior

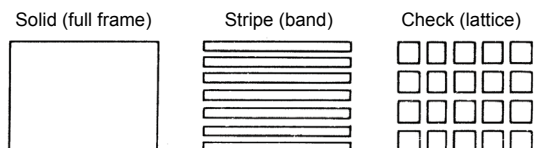

Example of printing with check pattern

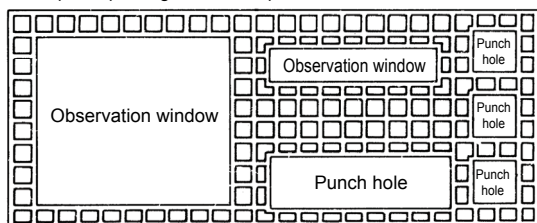

Example of printing with stripe pattern

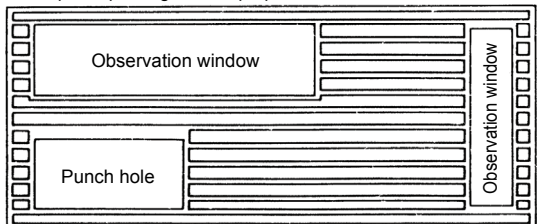

Direction of printing →

Figure 13. Examples of screen printing patterns

characteristics of screen printing, PSAs must also possess several characteristics that meet the demands of such applications.

4-1. Viscosity Characteristics

Viscosity is one property that significantly affects printing results. Low viscosity results in drooping and bleeding. Conversely, high viscosity results in thin spots.

Good slump resistance helps achieve the required adhesive thickness and prevents bleeding and drooping. Generally, increasing viscosity improves slump resistance.

While the appropriate value for viscosity depends on the thickness of the coated adhesive layer, a viscosity of around 20-30 Pa·s (= 200-300 P) is considered appropriate for forming adhesive layers of 50 μm or more.

4-2. Leveling and Defoaming Properties

In screen printing, PSA is applied to the adherend through the mesh of the screen. The coating is initially applied in a fine mesh pattern. If any air bubbles are present on the surface of the printed adhesive, the area of adhesion will be reduced. Thus, the adhesive must have appropriate leveling properties to eliminate air bubbles and form a smooth adhesive layer.

Poor leveling properties will result in a rough surface (an orange peel texture).

An uneven surface on the adhesive layer will result in insufficient adhesive area and reduce the strength of the adhesion. Defoaming properties are another important characteristic affecting the formation of a smooth adhesive surface.

4-3. Thixotropy (Thixotropic Property)

Misting, which occurs due to PSA forming a thread as the plate detaches from the adherend, is a common problem encountered in screen printing, one that ruins printed surfaces.

Misting is often encountered when solvent PSAs with high molecular weights are used in high concentrations.

To suppress misting, we improve the thixotropic properties of an adhesive.

4-4. Drying Characteristics

Changes in viscosity during screen printing attributable to evaporation of the dispersing medium is an undesirable condition. In addition, the start of adhesive drying on the screen can clog the mesh.

We can add solvents to control the drying characteristics of the adhesive. Usually, slow-drying solvents are selected as the additive, but for emulsions, we can add water-retaining agents (e.g., compounds likely to form hydrates).

On the other hand, to reduce the time required for drying, high-concentration emulsions can be employed or lower alcohols added to the emulsion to enhance drying characteristics.

5. Water-Based Pressure-Sensitive Adhesives from ThreeBond

From early on, ThreeBond focused on coating technologies for pressure-sensitive adhesives that apply the characteristic processes of screen printing.

One emulsion system pressure-sensitive adhesives for screen printing marketed by our company is ThreeBond 1549.

ThreeBond 1549 takes full advantage of its emulsion properties. Although the product has high molecular weight, there is no stringing, and viscosity and leveling properties are appropriately controlled.

The following are the properties of TB1549.

Table 6. Properties of ThreeBond 1549

Main component	Acryl emulsion
Appearance	Creamy white Colorless and transparent (dried film)
Viscosity	20 Pa•s {200P} (25°C)
Residual on heating	67%
Specific gravity	1.01
pH	6.0

Table 7. Holding strength of ThreeBond 1549

Holding strength	1.0 mm	40°C, 1 kg loading for 1 hour
Tack	16	Based on ball tack test

Table 8. Peeling strength on various adherends

	90° peeling strength (unit: N/m)	180° peeling strength (unit: N/m)
PVC/PS	470	980
PVC/ABS	390	1450
PVC/PMMA	430	1220
PET/PS	430	780
PET/ABS	550	700
PET/PMMA	470	820

(1 kgf/25 mm = Approximately 400 N/m)

Symbol

PS: polystyrene resin

PVC: chlorinated vinyl (soft) resin

ABS: ABS resin

PMMA: Acrylic resin

PET: Polyethylene terephthalate resin

Table 9. Peeling strength and film thickness

	Mesh	Film thickness after drying (unit: μm)	90° peeling strength (unit: N/m)
PVC/PS	80	60 ~ 70	550
	100	50 ~ 60	470
	120	40 ~ 50	430
PVC/PMMA	80	60 ~ 70	510
	100	50 ~ 60	430
	120	40 ~ 50	350

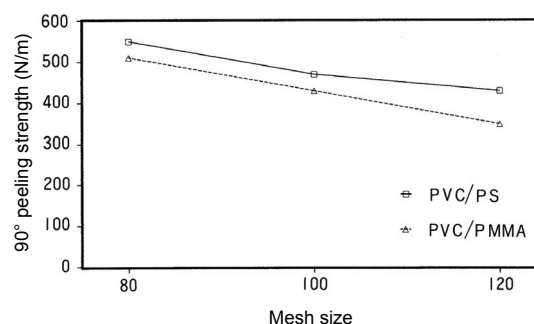

Figure 14. Peeling strength and mesh size

Table 10. Peeling strength upon heating

	90° peeling strength (unit: N/m)			
	25°C	40°C	60°C	80°C
PVC/PS	470	200	160	80
PVC/PMMA	430	200	160	80

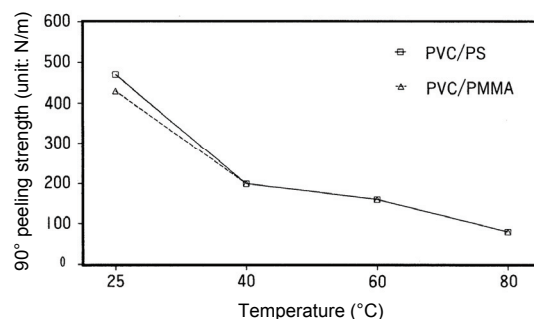

Figure 15. Peeling strength upon heating

Table 11. Change in peeling strength with time

Temperature conditions	90° peeling strength (unit: N/m)							
	Blank	6 hours	1 day	3 days	7 days	15 days	30 days	60 days
-40°C	470	390	390	430	430	430	390	430
0°C		430	430	430	470	390	390	390
Room temperature (25°C)		470	470	430	470	470	470	510
40°C		390	430	430	470	510	470	510
70°C		390	430	430	470	470	470	430
40°C 95% RH		390	390	390	430	430	430	510
60°C 95% RH		350	430	390	470	470	510	510

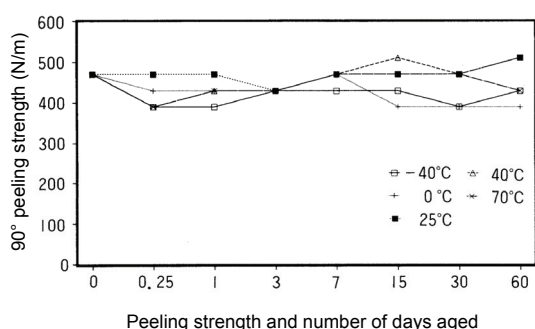

Figure 16. Aging period (days)

Caution!

The water used to wash screen plates and apparatus to which TB1549 adheres must be treated as industrial waste. Do not release into the sewage system. Please contact a company specializing in waste treatment to process the wastewater.

Conclusion

We prepared the present paper as an introduction to pressure-sensitive adhesives, emulsions, and screen printing. Explanations of complex topics such as fusion theory of emulsion particles have been omitted due to lack of space. Those who may have expected a more advanced theoretical treatment may find this somewhat disappointing. We direct the latter readers to the literature listed at the end.

Listed below are the references used to prepare this report.

Integrated Essentials in Solid State Physical Chemistry edited by Masayuki Nakagaki (published by Nankodo Co., Ltd.)

Pressure-Sensitive Adhesives, Mitsuo Toyama (published by Kobunshi Kankokai)

Special issue of Kobunshi Kako (Polymer Processing), Vol. 8, "Pressure-Sensitive Adhesion" (published by Kobunshi Kankokai)

Progress and Current State of Colloidal Chemistry by Kenjiro Meguro et al. (published by Nikko Chemicals Co., Ltd.)

Introduction to Emulsion Application by Masaaki Yura (published by Kobunshi Kankokai)

Chemistry of Polymer Latex by Soichi Muroi (published by Kobunshi Kankokai)

Comprehensive Technical Handbook on New Screen Printing Technologies, Precision Technologies and Troubleshooting (published by Nihon Software Laboratory)

Complete Collection of Screen Printing Technologies (published by Serigraph Co.)

Notes on Pressure-Sensitive Adhesive Applications (Kogyo Chosakai Publishing Co., Ltd.)

ThreeBond
TECHNICAL NEWS

THREE BOND CO., LTD.

1456 Hazama-cho, Hachioji-shi, Tokyo 193-8533, Japan
Tel: 81-426-61-1333