

XSDB 701-54



Dry Cabinet



Outstanding performance

The XSD series has an outstanding performance for drying moisture sensitive components and pcb's.

The dynamic drying unit of the 5000 series reaches very reliable low humidity values of $\leq 0,5\%RH$ and automatically regenerates if necessary.

As a result of an insulated double metal sandwich construction a precise temperature of $60^{\circ}C$ can be reached with a very low power consumption.

A radial fan and heater supports the drying process and realizes an equable temperature and moisture level in the cabinet. The relevant process data is obtained by use of an accurate Rotronic sensor.



XSDB 701-54

Standard features

✓ User friendly handling	Touchscreen display with easy menu structure
✓ ESD features	Norm (IEC 61340-5-1) ESD stainless steel body (10^3 Ohm/sq) Conductive glazing (in- and outside 10^3 Ohm/sq)
✓ Insulation	60 mm sandwich construction with Polyurethane
✓ Online functionality	Interface and data logging through standard Ethernet interface Compatible with new MSL 2.0 software
✓ Door & humidity alarm buzzer	Longer door openings are detected, high RH levels are detected
✓ Leveling out	Adjustable legs
✓ Lockable doors	Every door can be locked separately with a key.
✓ Shelves	In height adjustable sliding shelves (5 pcs)
✓ U-5000 series drying unit	$\leq 0,5\%$ RH, made in Germany
✓ Rotronic sensor	Precision sensor, accuracy +/- 0,8 % RH, +/- 0,3°C
✓ Power supply	Power cord 5 meter with IEC plug

Benefits

✓ Drying time (see reference table)	Fast drying time, Level 3 component, $1,4\text{ mm}$ = 18 hours (60°C / 1% RH)
✓ Recovery time after door opening	< 6 minutes
✓ Temperature stability	The same temperature level throughout the drying cabinet as a result of the use of a radial fan in combination with ventilation and heating canal in an insulated sandwich construction
✓ Temperature setting	Heating up to 40°C (optional to 60°C), accuracy +/- 2°C
✓ Energy saving consumption	As a result of a Dynamic dry unit, sandwich construction with insulating Polyurethane.
✓ Network	Standard ethernet interface
✓ IPC	According to IPC-Jstd 033C
✓ European Quality	Made in Germany
✓ Maintenance	Easy to service, low maintenance

XSDB 701-54

Technical data cabinet

- ✓ External dimensions: (W x H x D) 700 x 1930/2110 x 808 mm
- ✓ Internal dimensions: (W x H x D) 544 x 1504 x 600 mm
- ✓ Weight: 142 kg
- ✓ Weight on shelf: 50 kg
- ✓ Shelves (WxD): 5 pcs, 535 x 550 mm. (max 15 pcs.)
- ✓ Volume: 490 L
- ✓ Electric supply: 230 VAC (120 VAC optional)
- ✓ Power consumption: 450 W/h (60° C)
- ✓ Protection class: Class 1, hard grounded
- ✓ Humidity level cabinet: ≤0,5% RH can be reached with drying unit U-5003
- ✓ Sensor accuracy: +/- 0,8 % RH, +/- 0,3°C
- ✓ Temperature accuracy: 60° C, +/- 2° C

Technical data type 4 display

Settings

- ✓ Language Menu
- ✓ Nominal Value Humidity
- ✓ Humidity Alarm
- ✓ Delay Humidity Alarm
- ✓ Nominal Value Temperature (in combination with heater)
- ✓ Temperature Alarm (in combination with heater)
- ✓ Delay Temperature Alarm (in combination with heater)
- ✓ Sensor Offset
- ✓ Password Protection
- ✓ Manual Regeneration

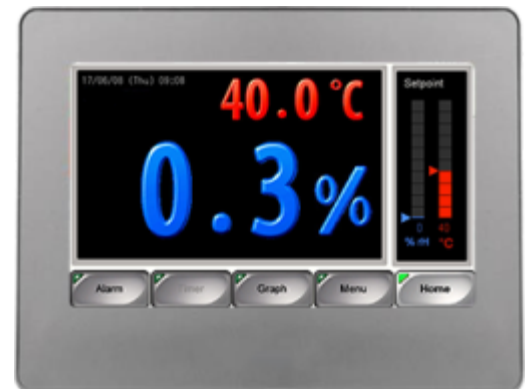

Display

- ✓ Supply voltage (supplied by drying unit) 24 VAC/DC, 350 mA
- ✓ Input Touchscreen
- ✓ TFT Color LCD 4,3"
- ✓ Controllable Brightness
- ✓ Standard Ethernet Interface
- ✓ USB Interface for data logging purposes

XSDB 701-54

Technical data Rotronic sensor HC2A-s



Based on the Airchip 3000 Technology use the HygroClip 2 probes can be used for control of temperature and humidity.

The HygroClip 2 probes can be configured with the ROTRONIC HW4 software and share the following features:

- ✓ Measurement of relative humidity and temperature.
- ✓ Programmable automatic sensor test with failsafe mode and sensor drift compensation.

Technical data dry-unit U-5000 series

- ✓ Dehumidifying performance: 120 g/h max.
- ✓ Minimal humidity 0,2% RH
- ✓ Dehumidifying Temperature 10 – 60° C
- ✓ Electric supply: 230 VAC
- ✓ Dimensions (L x B x H): 487 x 487 x 150 mm
- ✓ Weight: 14 kg



XSDB 701-54

Free Totech viewer

- ✓ Writing of climate data, door openings and alarms to SD card
- ✓ Transfer data through Ethernet to PC (history data)
- ✓ User-friendly display of all relevant data
- ✓ Data processing in MS-Excel

- ✓ Seamless documentation
- ✓ Excellent process safety

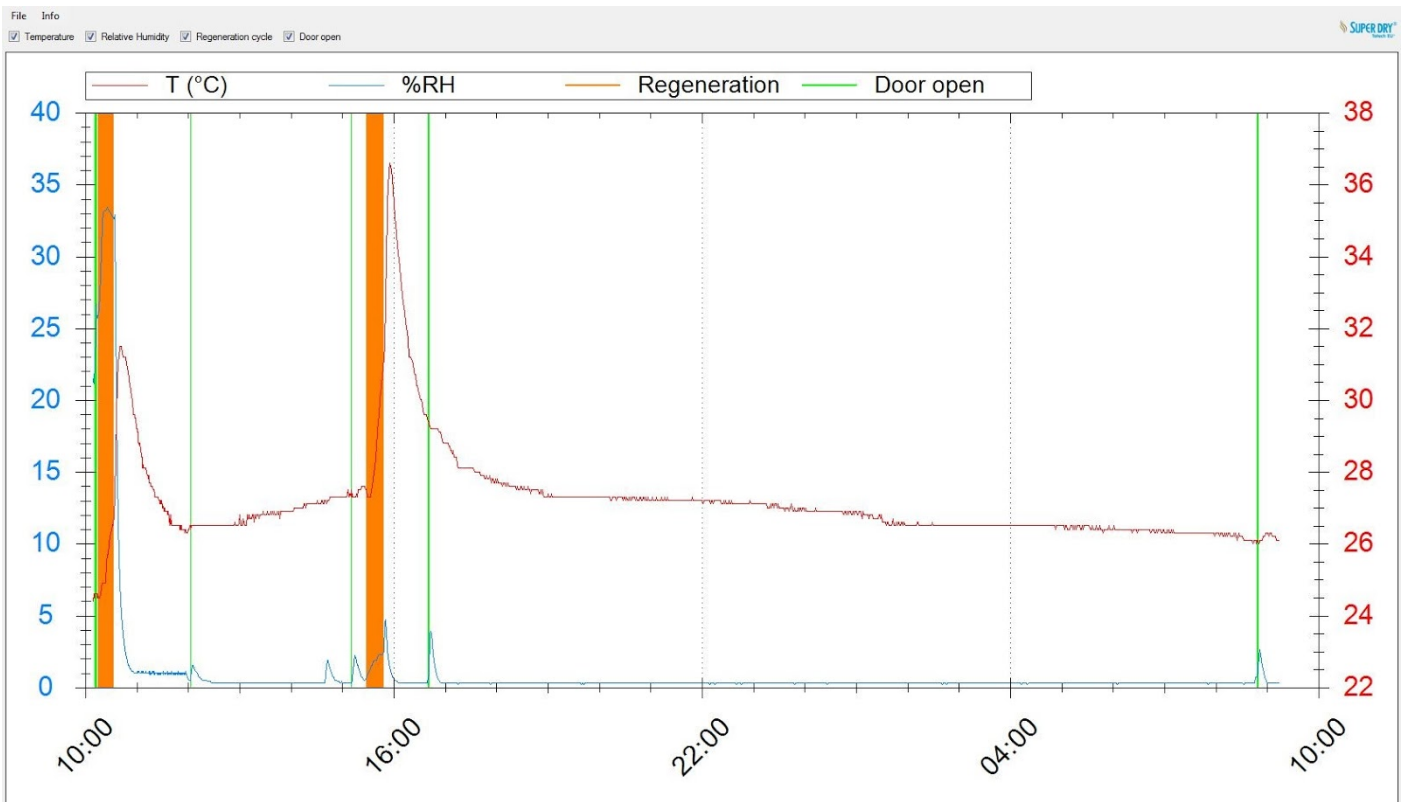

Performance test

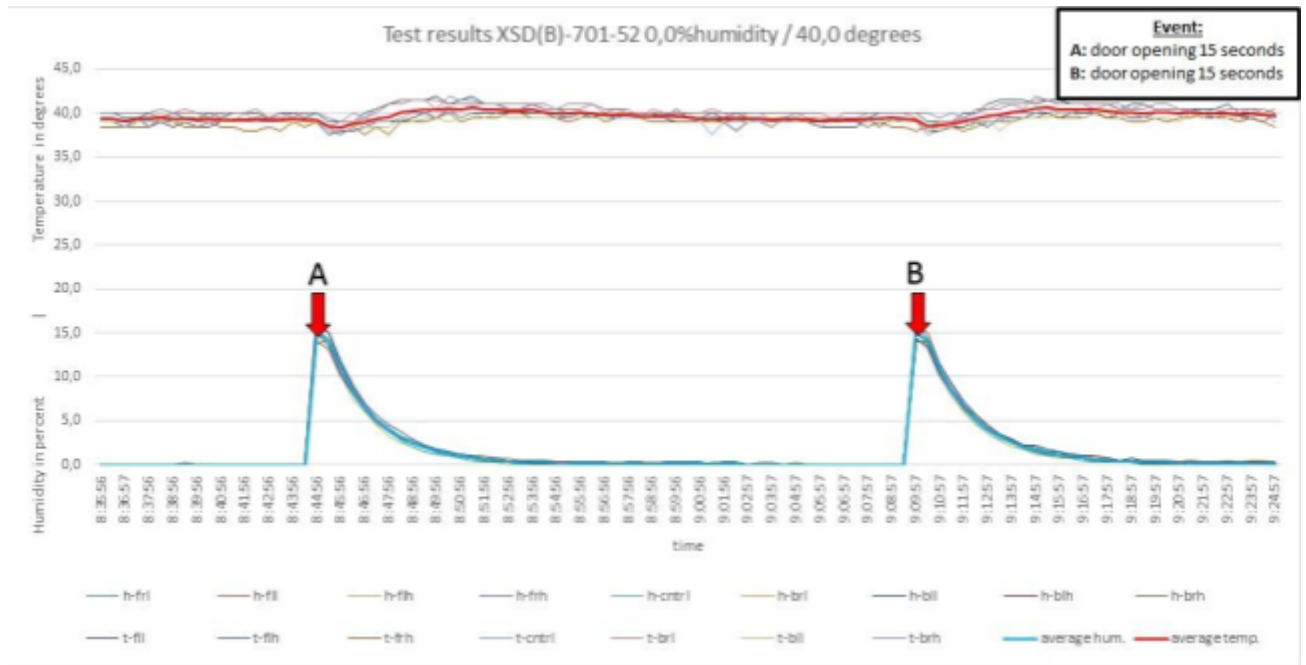

Test conditions

- ✓ Type of dew point sensor: 9x Hygroclip HC2A-S
- ✓ Accuracy of dew point sensor: $\pm 0,3^{\circ} \text{C}$ at $+ 20^{\circ} \text{C}$ ($+ 68^{\circ} \text{F}$)
- ✓ Location of sensors: Every corner + center
- ✓ Ambient conditions: Hum. $50 \pm 5\% \text{ rH}$, $22^{\circ} \text{C} \pm 2^{\circ} \text{C}$, Pressure $994 \pm 20 \text{ hPa}$
- ✓ Door openings: 2 door openings, 15 sec.

For more detailed test results, please refer to our website.

Technical drawings

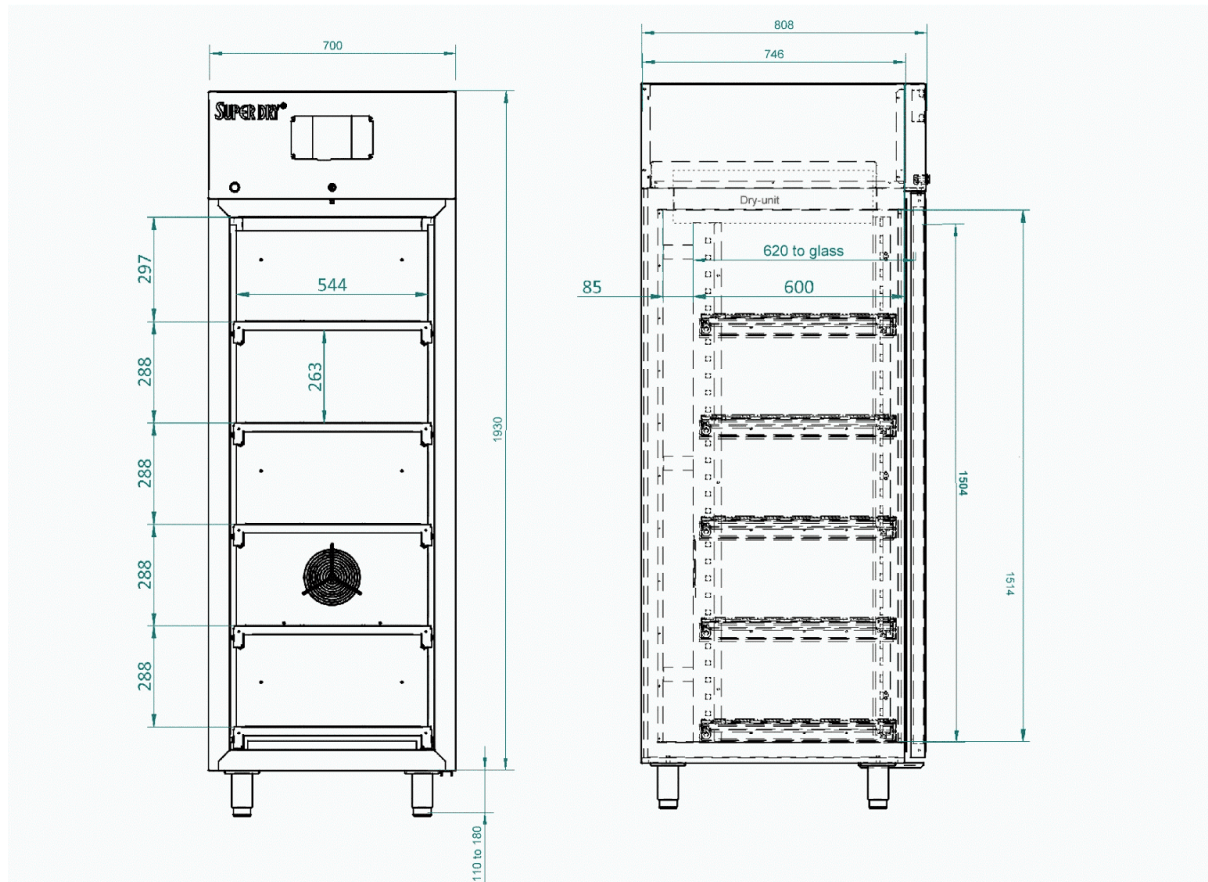

Dimensions mentioned in mm.

Shelves

Number of different types of shelves that can be mounted in the cabinet

Number of shelves (47000136)	5	6	7	8	9	10	11	12	13	14	15
Distance (in mm) between shelves if equally divided	280	230	180	180	130	130	80	80	80	80	80
Remaining space between top shelf and top cabinet	330	285	330	140	330	185	430	380	330	235	140

Number of shelves (47000140)	5	6	7	8	9	10	11	12	13	14	15
Distance (in mm) between shelves if equally divided	260	210	165	165	115	115	70	70	70	70	70
Remaining space between top shelf and top cabinet	235	190	235	40	235	90	430	330	235	140	40

Number of drawers	1	2	3	4	5	6	7	8	9	10	11	12	13	14	15
Remaining space in mm	1366	1270	1174	1078	982	886	790	694	598	502	406	310	214	118	22

XSDB 701-54

Technical drawings

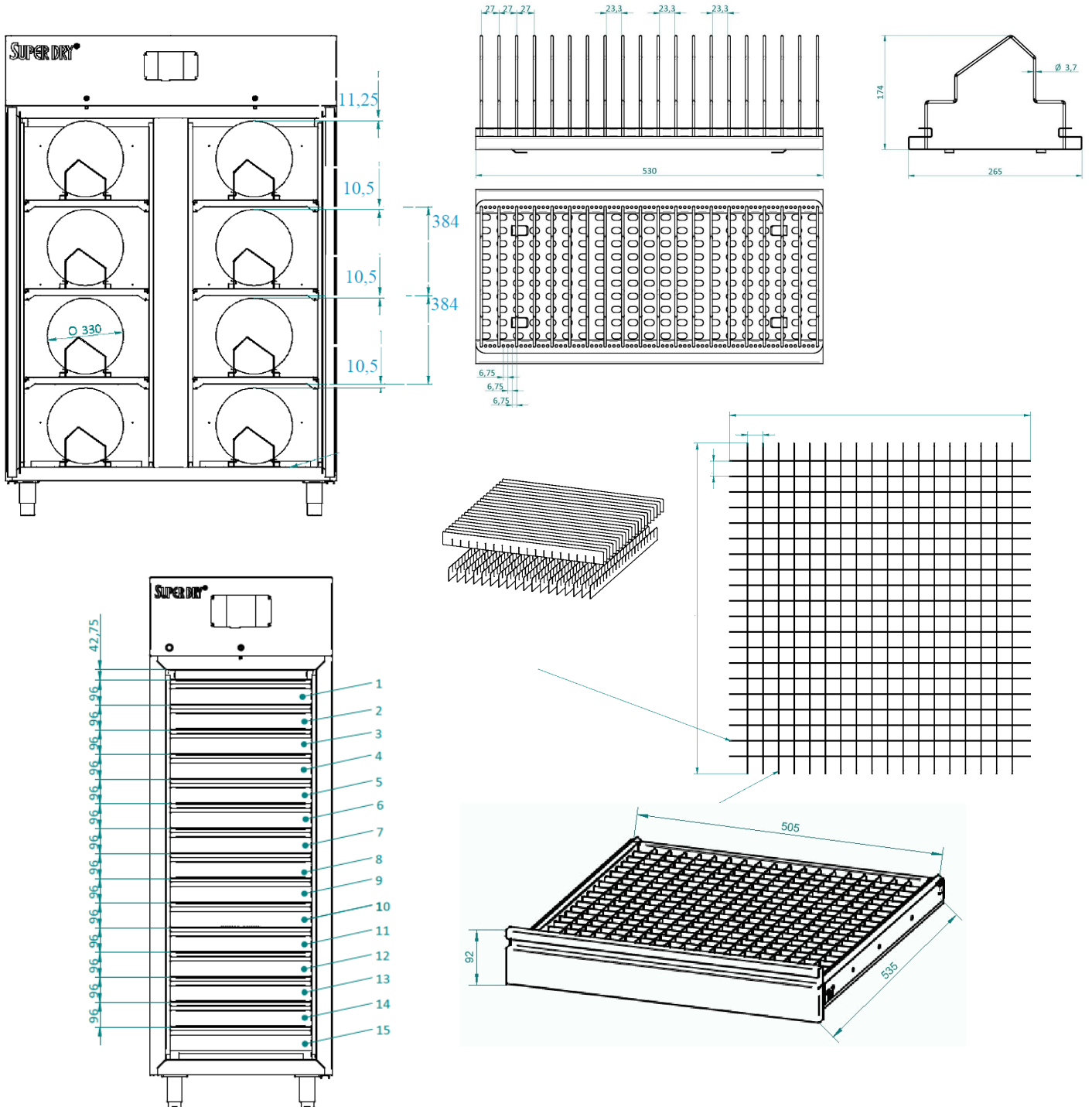

XSDB 701-54

Technical drawings

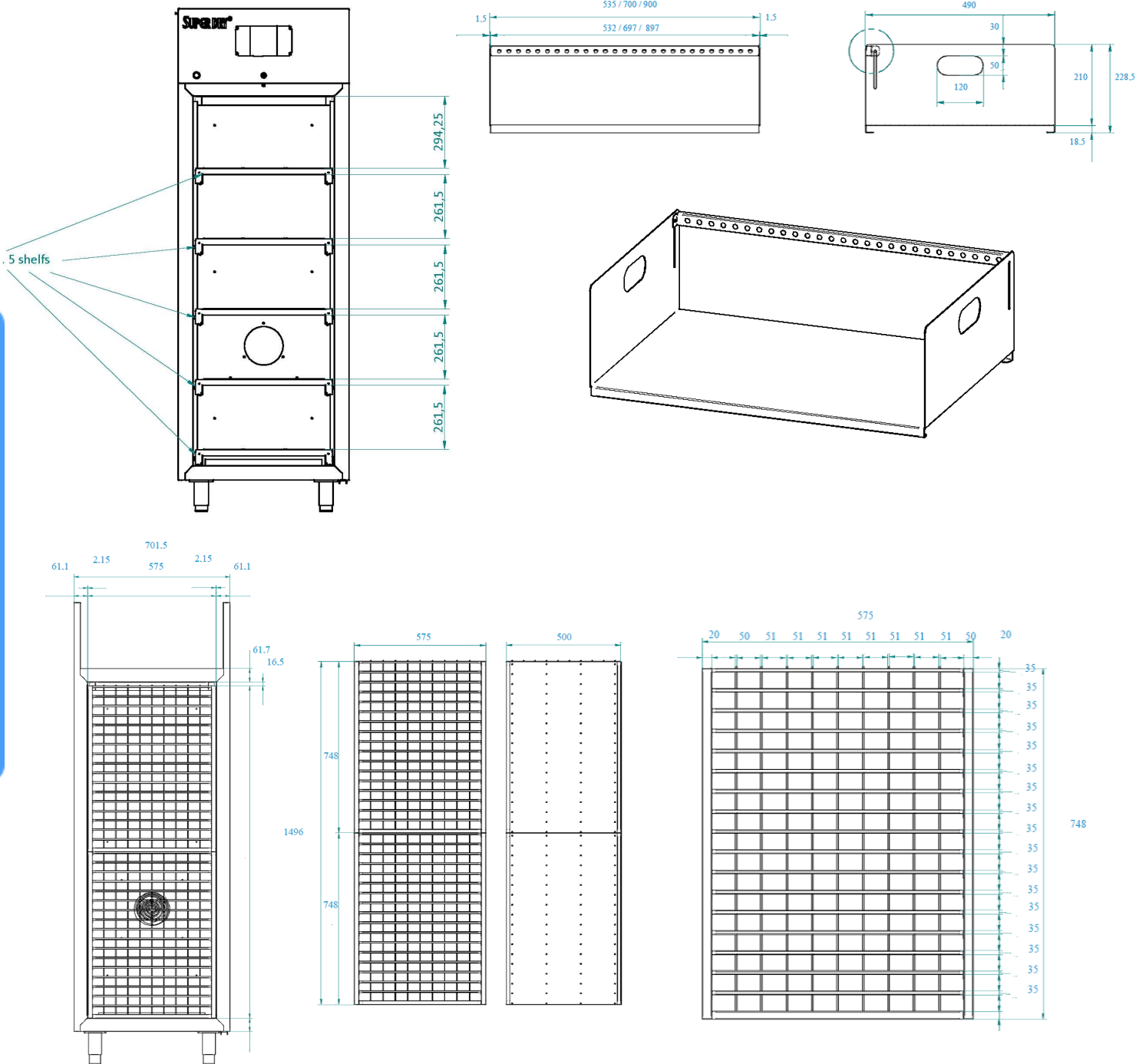

XSDB 701-54

Options



SMD Reel rack with reel supports

L x W = 530 x 265 mm incl. 18 reel supports.

Item number 20014005



Reel support

Additional reel supports for 20014005.

Item number 20014201



Door release pedal

These foot pedals enable you to open the doors keeping your hands free.

Item number 47000146



Humidity alarm signal lamp

Two-color (orange/green or red/green), magnetically fixed, providing optical signals on operational states and exceeded limit values. Operates on 24V.

Item number 20016030



N² Autoflow system

The autoflow system is developed to use in combination with a Totech drying cabinet. The device is used for the quick removal of moisture in the cabinet after the door has been opened. The drying process is realised by using nitrogen (N²), which is added automatically after the door has been closed. (by means of adjustable timer function).

Item number 22613066

XSDB 701-54

Options



Additional shelves
Stainless steel shelf without rollers.

Item number 47000136



Additional sliding shelves
Stainless steel sliding shelf on metal rollers, 100% extractable

Item number 47000140



Drawer
Stainless steel drawer

Item number 47000127

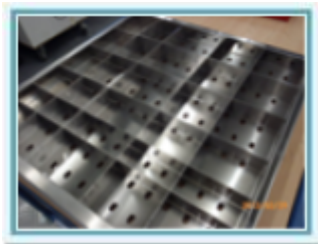

Divider system drawer
Stainless steel divider system which enables you to create compartments with a minimum measurement of +- 2,5 x 2,5 cm or a multiple of 2,5 cm. A standard set contains 5 long strips (553 mm) and 5 short strips (502 mm).

Item number 4700129



Cover plate for XSD shelves
Prevent small items to fall through

Item number 47000132

XSDB 701-54

Options



Honeycomb system

Flexible stainless steel storage system for IC Tubes components and PCB's. The width of the compartments is adjustable before installing the system in the cabinet. The number of compartments varies from 17 till 170. In total 4 systems can be installed in a cabinet.

Item number 20050100



X Feeder system

This feeder rack is suitable for Siemens X Feeder systems. Sold in combination with reel rack.

Item number 46204004



S Feeder system

This feeder rack is suitable for S Feeder systems. Sold in combination with reel rack.

Item number 46204009



Hygroclip 2

Probe with maximum accuracy for all climate measurements.

Item number 47000027

Exchange calibrated sensor:

Item number 47000040



Humidity calibrator Hygropalm 22

Precision measuring device for calibrating sensors.

Set including Hygroclip sensor, case and cable:

Item number 20001019

Hygropalm only:

Item number 20001016

XSDB 701-54

Options

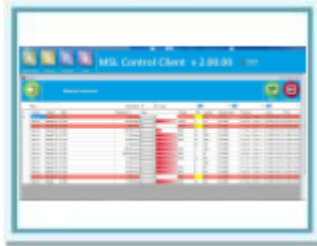

MSL 2.0 software for 1000 components

Software solution for the monitoring of moisture sensitive components and their MSL states during storage and processing in the production. The exact drying state individually for each component is monitored and displayed with the software. One of the possibilities is that it can read out multiple HC2A-S sensors. To adjust storage conditions, picking of stock, removal of used parts and more stock control. A complete history for each component is traceable up to the full processing. The evaluation of the drying conditions is based on the requirements of the IPC / JEDEC J-STD-033B1 directive.

Item number 20010036



MSL software upgrade with additional 1000 components

Upgrade to monitor an additional 1000 components

Item number 200174502



Totech Monitor software

Realtime cabinet monitoring with alarm function, sending e-mails with detailed information on the status of the cabinet. History data files with graphical overview

Item number 47000583

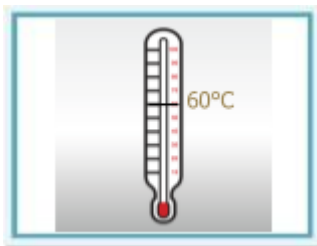

Upgrade for 60°C

Heater 60°C for XSDB

Item number 21001505



Touchscreen display 7 inch

Bigger 7" touchscreen display

Item number 30022222

v17.12