

www.atten.com

ATTEN

Product Catalog

2023



ABOUT US

- ✧ Shenzhen ATTEN Technology Co., Ltd was established in 1999, we are a professional manufacturer of producing soldering equipment and power supply over 27 years.
- ✧ As a member of Soldering Station Standard Setting Group and National Technical Committee on Standardization of Household Appliances, ATTEN products have got approvals of “CE”, “RoHS”, “SAA” and other qualifications.
- ✧ We are located in ShenZhen with convenient transportation access. ATTEN got the ISO 9001:2015 international quality system authentication and won the National High-tech Enterprise, Shenzhen Well-known Brands and a number of honorary titles.
- ✧ We provide TWO years quality guarantee for main unit, and specialized after-sales service.
- ✧ ATTEN sell our own brand and also welcome OEM orders, whether selecting a current product from our catalog or seeking engineering assistance for your application, you can contact our customer service center for your sourcing requirements.
- ✧ Welcome to be our partner!



CONTENT

Multifunctional Maintenance System

GT-6150	02
GT-6200	03
GT-5150	04
GT-8102	05
GT-1028	06
MS-900	08
GT Series Accessories	10
Integrated heater	13
MS-300	14
MS-500	15

Soldering / Desoldering Station

ST-1503, ST-1503D	16
T500 soldering tips	17
ST-60, ST-80, ST-100	18
T800 soldering tips,Integrated heater T990	19
ST-909	20
ST-965	21
ST-1509	22
ST-2090D	23
AT-937A,AT-989,AT-989D	24
ST-862D	25
ST-8800D	26
AT-852D,AT-850D	27
ST-8902D	28
ST-8802	29
AT-8502D	30
T900	31
Nozzles	32
Handle	34
GT-2010+	35
ST Series Soldering Iron	36
T10,T2080,T2150 soldering tips	37

Other Equipments

Fume Extractor	38
Hot Air Gun	40
Temperature tester ST-1090	41
Hot Melting Glue Gun & Solder Smoke Absorber	42

Tool Accessories

Magnifying Frame, Tweezers	43
Soldering Wire	44
Soldering tip cleaner, Tin Slag Box & Solder Stand	47
Soldering Wire Stand & Solder Pot	48
Soldering Wick	49
Desoldering tool & Vacuum pick-up tool	50
Tip Refresher & Rosin Flux flux & Solder paste flux	51
Wrist Strap & Wrist Strap On-line Monitor	52

Power Supply

APS15-3A/APS22-5A	53
TPR3003T/TPR3005T	54
TPR32-5A / TPR75-2A	55
TPR6005T/TPR6010T	56
TPR3020T/TPR3010T	57
KPS3030DA/KPS3050DA	58
TPS300P	59
CP600-30V/30A/CP900-30V/30A	60
PR35-3A-3C / PR35-5A-3C	62
PR35-3A-3CP / PR35-5A-3CP	64

Multifunctional Maintenance System



Rapid temp recovery

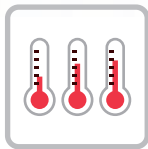

Preset temp



ESD safe



Auto sleep



Password function



Auto standby

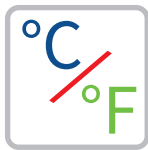

°C/°F available



Fault display



Automatic identification



Software control

Computer control



GT-6150

Single Channel High-end Intelligent Unleaded Soldering Station



Features:

- Single channel soldering station with LCD display.
- Max power is 150W.
- Using integrated soldering tips, rapid heating.
- Pluggable heater design, easy to replace.
- Silicone buttons operate comfortable.
- 3 sets shortcut temperature to simplify operations.
- Auto standby and sleep function, conserves energy and protect equipment.
- Password-protected function to preserve settings.
- Compatible with GT-Y050,GT-Y130,GT-Y150 and GT-N100 handles.
- Built-in RS-232 communication interface, support computer control.

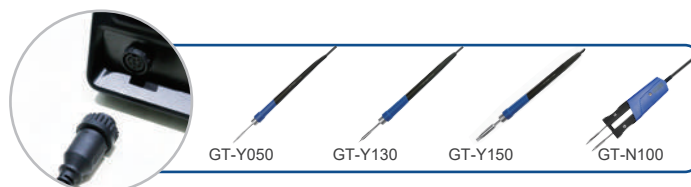
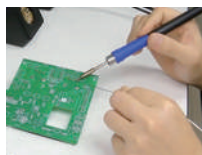

Automatic identification

Specification:

Model	GT-6150		
Voltage	AC(100V/110V/120V/220V/230V/240V) 50/60Hz (Optional)		
Power	150W		
Temperature range	150°C~480°C		
Handle	GT-Y130		
Soldering tip/heater	Integrated T130-1.0I		
Soldering stand	S-01		
Inner box	375x345x225(mm)		
N.W.	4.11KG		
G.W.	6.33KG		
Package list	GT-6150 host: 1 Set Operation manual: 1 Set Power cord : 1 Pcs	Certificate of qualification : 1 Pcs 3.5mm grounding receptacle : 1 Pcs GT-Y130 handle set : 1 Pcs	S-01 Iron stand : 1 Pcs
Applications	<ul style="list-style-type: none"> • Institutes/Enterprises • Education and practice 	<ul style="list-style-type: none"> • Maintenance • Hobby soldering 	

Note: GT series optional handles details in page 10.

Note: Integrated heater details in page 11-12.
(T50/T100/T130/T150)

GT-6200

Dual Channel High-end Intelligent Unleaded Soldering Station

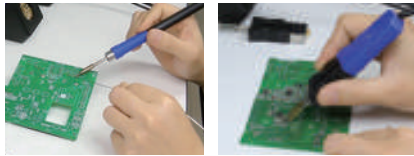

Features:

- Dual channels soldering station with a soldering iron and a electronic tweezer with LCD display.
- Two output channels can work at the same time.
- Max power is 200W.
- Using integrated soldering tips, rapid heating.
- Pluggable heater design, easy to replace.
- Silicone buttons operate comfortable.
- 3 sets shortcut temperature to simplify operations.
- Auto standby and sleep function, conserves energy and protect equipment.
- Password-protected function to preserve settings.
- Compatible with GT-Y050,GT-Y130,GT-Y150 and GT-N100 handles.
- Built-in RS-232 communication interface, support computer control.

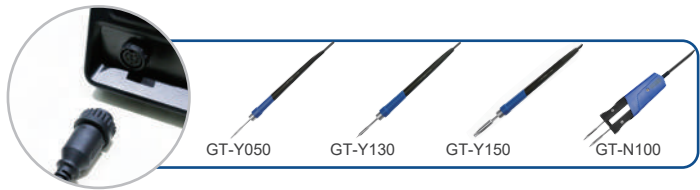

Automatic identification

Specification:

Model	GT-6200		
Voltage	AC(100V/110V/120V/220V/230V/240V) 50/60Hz (Optional)		
Power	200W		
Temperature range	150°C~480°C		
Handle	GT-Y130,GT-N100		
Soldering tip/heater	Integrated T130-1.0I,T100-0.5I		
Soldering stand	S-01,S-02		
Inner box	458x370x225(mm)		
N.W.	4.97KG		
G.W.	7.26KG		
Package list	GT-6200 host: 1 Set Operation manual: 1 Set Power cord : 1 Pcs	Certificate of qualification : 1 Pcs 3.5mm grounding receptacle : 1 Pcs GT-Y130 handle set : 1 Pcs	S-01 Iron stand : 1 Pcs GT-N100 tweezers handle : 1 Pcs S-02 Iron stand : 1 Pcs
Applications	<ul style="list-style-type: none"> • Institutes/Enterprises • Education and practice 		<ul style="list-style-type: none"> • Maintenance • Hobby soldering

Note: GT series optional handles details in page 10.

Note: Integrated heater details in page 11-12.
(T50/T100/T130/T150)

GT-5150

Single Channel High-end Intelligent Unleaded Suction Soldering Station



Desoldering Nozzles



Features:

- Single channel suction soldering station with LCD display.
- Built-in vacuum suction pump.
- Max Power is 150W.
- Using integrated soldering tips, rapid heating.
- Pluggable heater design, easy to replace.
- Silicone buttons operate comfortable.
- 3 sets shortcut temperature to simplify operations.
- Auto standby and sleep function, conserves energy and protect equipment.
- Password-protected function to preserve settings.
- Compatible with GT-Y050,GT-Y130,GT-Y150 and GT-N100 handles.
- Built-in RS-232 communication interface, support computer control.

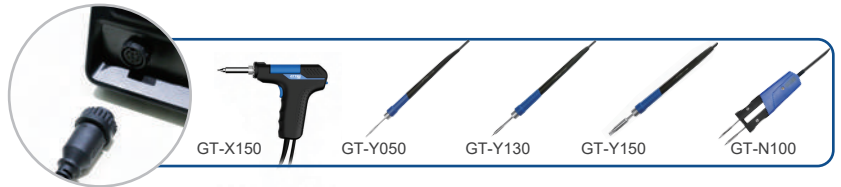

Automatic identification

Specification:

Model	GT-5150		
Voltage	AC(100V/110V/120V/220V/230V/240V) 50/60Hz (Optional)		
Power	150W		
Temperature range	300°C~480°C		
Handle	GT-X150		
Desoldering nozzles	T151-0.8,T151-1.0,T151-1.3,T151-1.6		
Soldering stand	S-03		
Inner box	375x345x225(mm)		
N.W.	5.05KG		
G.W.	7.32KG		
Package list	GT-5150 host: 1 Set Operation manual: 1 Set Power cord : 1 Pcs	Certificate of qualification : 1 Pcs 3.5mm grounding receptacle : 1 Pcs GT-X130 desoldering gun : 1 Pcs	S-03 Soldering stand : 1 Pcs Desoldering nozzles: 3 Pcs
Applications	<ul style="list-style-type: none"> • Institutes/Enterprises • Education and practice 	<ul style="list-style-type: none"> • Maintenance • Hobby soldering 	

Note: GT series optional handles details in page 10.

Note: Integrated heater details in page 11-12.
(T50/T100/T130/T150)

Note: Desoldering nozzles
in page11

GT-8102

Intelligent High Power Hot Air Rework Station



A1604
Φ4mm



A1606
Φ6.5mm



A1609
Φ9.5mm

Features:

- 1000W high power hot air rework station with LCD display.
- Max air volume is 120L/min.
- Equip with a vacuum suction pen, components can be extracted after desoldering.
- Built-in brushless fan, long use life and low noise.
- 3 sets shortcut air volume / temperature to simplify operations.
- Support timing work.
- Password-protected function to preserve settings.
- Temperature curve setting function.
- Auto standby and sleep function, conserves energy and protect equipment.
- Air blow delay after power off function.
- Built-in RS-232 communication interface, support computer control.



Specification:

Model	GT-8102			
Voltage	AC(100V/110V/120V/220V/230V/240V) 50/60Hz (Optional)			
Power	1000W			
Temperature range	100°C~480°C			
Handle	GT-R102			
Desoldering nozzles	Nozzles:(φ4mm、φ6.5mm、φ9.5mm)			
Soldering stand	Air gun holder			
Inner box	410x305x215(mm)			
N.W.	5.08KG			
G.W.	6.81KG			
Package list	GT-8102 host: 1 Set	Handle holder : 1 Pcs	Hot air gun handle: 1 Pcs	Suction disc: 4x3 Pcs
	Operation manual: 1 Set	Spray nozzle : 3 Set	Conformity certificate: 1 Set	
	Power cord : 1 Pcs	Vacuum pen: 1 Set	Tool box: 1 Set	
Applications	<ul style="list-style-type: none"> • Institutes/Enterprises • Education and practice 		<ul style="list-style-type: none"> • Maintenance • Hobby soldering 	

GT-1028

ESD
SAFE

Intelligent Industrial IoT Hot Air Rework Station



Features:

- Big LCD color screen, more convenient to set and monitor parameters.
- 1300W pluggable ceramic heater, heating fast.
- Equipped with a vacuum suction pen, components can be extracted after desoldering.
- Built-in brushless fan, long service life and low noise.
- PID algorithm temperature control, accurate and stable temperature.
- Infrared temperature calibration function.
- Temperature curve setting function.
- 3 sets shortcut air volume/temperature to simplify operations.
- Support control the switch on and off of the smoke purifier.
- Can be controlled by external pedal.
- With RS485 communication interface, support IoT function.

Specification:

Model	GT-1028		
Voltage	AC(100V/110V/120V/120V/220V/230V/240V) 50/60Hz (Optional)		
Power	1300W		
Temperature range	100°C~500°C		
Air flow	120L/min(Max)		
Vacuum pressure	-80Kpa		
Heater	Pluggable HR-2102B		
Computer control	Yes		
Inner box	320x295x175(mm)		
N.W.	5.48kg		
G.W.	5.98kg		
Package list	GT-1028 host 1 Pcs Power cord 1 Pcs Hot air gun handle 1 Pcs Hot air gun nozzle 3 Pcs Hot air gun holder 1 Pcs	USB cable(A to B) 1 Pcs User manual 1 Pcs Vacuum pen(included tool box) 1 Pcs Bent suction nozzle 2 Pcs Straight suction nozzle 2 Pcs	Suction disc 4x3 Pcs Certificate 1 Pcs
Applications	<ul style="list-style-type: none"> • Institutes/Enterprises • Education and practice • Maintenance • Hobby soldering 		

Nozzles details in page 32.

IoT Function

Hot air station built-in 485 communication module(Wireless communication module can also be installed),can be docked with intelligent management platform software system,Realization: interconnected real-time monitoring, process preservation and copying, data storage and traceability, statistical analysis and management, monitoring and alarm prompts, remote control.

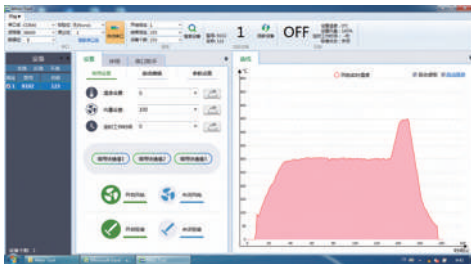

Using ATTEN computer software, it is easier to set parameters and edit curves
(Download it from www.attem.com)

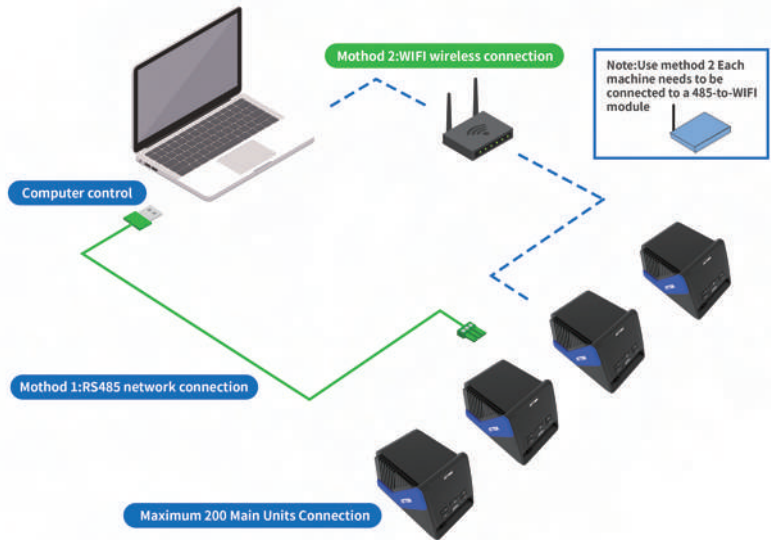

Control smoke purifier function



GT-1028 can control the switch on and off of the smoke purifier.

Pedal mode



When using an external foot switch, only the foot switch can control the heat gun to work.

MS-900 **ESD SAFE**

4 In 1 Intelligent Rework Station



Features:

- 4 in 1 intelligent rework station with LCD display.
- High accuracy MCU control is employed to synchronously detect 3 tool channels that can be used independently and synchronously without mutual interference.
- Built-in vacuum generator.
- Max power is 900W.
- Support doing multiple desoldering tasks simultaneously.
- Automatically identify all kinds of soldering tools and load corresponding parameters.
- Adjust the temperature by software automatically, more accurate and convenient.
- Fault display and alarm function.
- Equip with a vacuum suction pen, components can be extracted after desoldering.
- Auto standby and sleep function, conserves energy and protect equipment.
- Password-protected function to preserve settings.
- Built-in RS-232 communication interface, support computer control.



Automatic identification

Specification:

Model	MS-900			
Voltage	AC(100V/110V/120V/120V/220V/230V/240V) 50/60Hz (Optional)			
Total Power	900W			
Main unit	Hot Air Station	Soldering Station	Desoldering Station	Electronic Tweezer
Power	Heater 550W Air pump 25W	130W	Heater 150W, Vacuum pump 15W	100W
Handle	AP-552B	GT-Y130	GT-X150,GT-B001	GT-N100
Temperature range	150°C~500°C	150°C~500°C	300°C~500°C	150°C~500°C
Standby	No Standby	200°C	300°C	200°C
Standby time	No function	1~120 minutes (0 i.e. standby deactivated)	1~120 minutes (0 i.e. standby deactivated)	1~120 minutes (0 i.e. standby deactivated)
Air flow grades	23L/min	/	/	/
Noise	<52dB(A)	/	/	/
Temperature stability	±5°C	±2°C	±2°C	±2°C
Temperature compensation	- 50~+50°C			
Lock setting	Available			
Tip to ground impedance	<2Ω			
Tip to ground voltage	<2mV			
Overall dimension	310(L)x251(W)x119(H)mm			
Weight	N.W.: 14KG G.W.: 16KG			
Package:	Main unit: 1 set Air gun of soldering station: 1 pc Soldering iron stand: 1 pc Desoldering station handle: 1 pc Electric tweezer handle: 1 pc Desoldering gun handle: 1pc Desoldering pen handle: 1pc Power cord: 1 pc	Blow-dryer bracket: 1 pc Screw: 2 pcs Suction disk: 11 pcs Spring: 3 pcs Suction nozzle: 3 pcs Rubber washer: 2 pcs Desoldering nozzle: 3 pcs Nozzle: 4 pcs	Desoldering gun front plug: 2 pcs Desoldering gun O-ring 6x1.5: 2 pcs Desoldering gun O-ring: 2 pcs Desoldering tube liner: 1 pc Filter cotton: 10 pcs Dust-absorbing sponge: 10 pcs Spring pin(cleaning pin): 1 pc Anti-ironing mat: 1 pc	User Manual: 1
Applications	<ul style="list-style-type: none"> ● Institutes/Enterprises ● Education and practice ● Maintenance ● Hobby 			

GT Series

Accessories

GT-Y050

50W Mini Soldering iron

50W mini soldering iron,
suitable for small welding components

GT-Y130

130W Soldering iron

130W middle size soldering iron,
suitable for most welding components

GT-Y150

150W High- power Soldering iron

150W high- power soldering iron with sufficient heat
energy, suitable for welding large bonding pad and
weldments

GT-N100

100W Tweezers handle

With soldering and desoldering function,
suitable for soldering and desoldering various SMD devices

GT-X150

150W Desoldering gun

High power, heating up quickly, minimize damage to PCB boards.
New design with replaceable nozzle, heat conducting quickly,
high efficiency and low cost



Integrated heater (50W)

<p>T50-0.1IS / T950-0.1IS</p>	<p>T50-0.3IS / T950-0.3IS</p>	<p>T50-0.1SI / T950-0.1SI</p>	<p>T50-0.3SI / T950-0.3SI</p>
<p>T50-0.5I / T950-0.5I</p>	<p>T50-1.2C / T950-1.2C</p>	<p>T50-K / T950-K</p>	<p>T50-2.0SK / T950-2.0SK</p>
<p>T50-1.3D / T950-1.3D</p>	<p>T50-2.2D / T950-2.2D</p>	<p>T50-3.0D / T950-3.0D</p>	<p>T50-3.5SK / T950-3.5SK</p>

Integrated heater (100W)

		<p>T100-1.0I / T9100-1.0I</p>
<p>T100-0.2I / T9100-0.2I</p>	<p>T100-0.5I / T9100-0.5I</p>	<p>T100-0.30I / T9100-0.30I</p>
<p>T100-1.3D / T9100-1.3D</p>	<p>T100-2.2D / T9100-2.2D</p>	<p>T100-0.60I / T9100-0.60I</p>
<p>T100-1.00I / T9100-1.00I</p>	<p>T100-A0.30I / T9100-A0.30I</p>	<p>T100-A0.60I / T9100-A0.60I</p>

Desoldering Nozzles (T151)

<p>T151-0.8 ACF029749</p>	<p>T151-1.0 ACF029633</p>	<p>T151-1.3 ACF029634</p>	<p>T151-1.6 ACF029635</p>
-------------------------------	-------------------------------	-------------------------------	-------------------------------

Integrated heater (130W)

<p style="text-align: center;">142</p>			
<p style="text-align: center;">T130-1.2C / T9130-1.2C</p>	<p style="text-align: center;">T130-2.4C / T9130-2.4C</p>	<p style="text-align: center;">T130-3.2C / T9130-3.2C</p>	<p style="text-align: center;">T130-4.6C / T9130-4.6C</p>
<p style="text-align: center;">T130-1.6D / T9130-1.6D</p>	<p style="text-align: center;">T130-2.4D / T9130-2.4D</p>	<p style="text-align: center;">T130-3.2D / T9130-3.2D</p>	<p style="text-align: center;">T130-4.6D / T9130-4.6D</p>
<p style="text-align: center;">T130-0.5I / T9130-0.5I</p>	<p style="text-align: center;">T130-1.0I / T9130-1.0I</p>	<p style="text-align: center;">T130-K / T9130-K</p>	<p style="text-align: center;">T130-C / T9130-C</p>
<p style="text-align: center;">T130-SI / T9130-SI</p>	<p style="text-align: center;">T130-0.5IS / T9130-0.5IS</p>	<p style="text-align: center;">T130-SK / T9130-SK</p>	<p style="text-align: center;">T130-2.0SK / T9130-2.0SK</p>
<p style="text-align: center;">T130-0.1SI / T9130-0.1SI</p>	<p style="text-align: center;">T130-0.2SI / T9130-0.2SI</p>	<p style="text-align: center;">T130-0.3SI / T9130-0.3SI</p>	<p style="text-align: center;">T130-0.1IS / T9130-0.1IS</p>
<p style="text-align: center;">T130-2.0CM / T9130-2.0CM</p>	<p style="text-align: center;">T130-3.0CM / T9130-3.0CM</p>	<p style="text-align: center;">T130-H / T9130-H</p>	<p style="text-align: center;">T130-0.3IS / T9130-0.3IS</p>
<p style="text-align: center;">T130-15D / T9130-15D</p>	<p style="text-align: center;">T130-20D / T9130-20D</p>		

Integrated heater (150W)

<p style="text-align: center;">155</p>			
<p style="text-align: center;">T150-3C / T9150-3C</p>	<p style="text-align: center;">T150-5C / T9150-5C</p>	<p style="text-align: center;">T150-6.5C / T9150-6.5C</p>	<p style="text-align: center;">T150-B / T9150-B</p>
<p style="text-align: center;">T150-3.2D / T9150-3.2D</p>	<p style="text-align: center;">T150-4.6D / T9150-4.6D</p>	<p style="text-align: center;">T150-6.5D / T9150-6.5D</p>	<p style="text-align: center;">T150-K / T9150-K</p>

GT Series Soldering handles Performance Test

HEATING UP TIME TEST

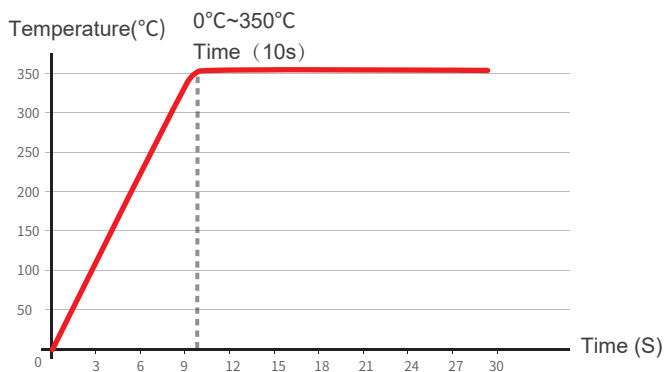

Fast heating up to set temperature, speed up working efficiency.

DROP TEMPERATURE RECOVER TIME CONTROL CURVE

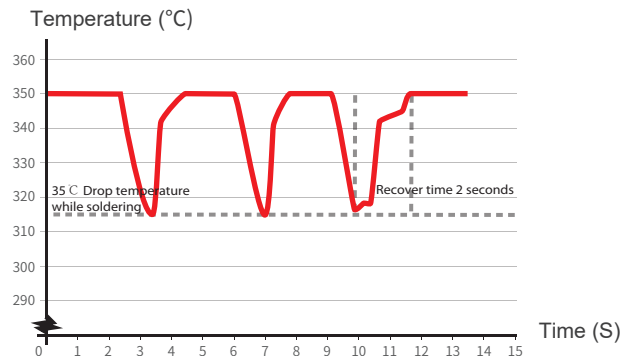

AUTO STANDBY & AUTO SLEEP ILLUSTRATION

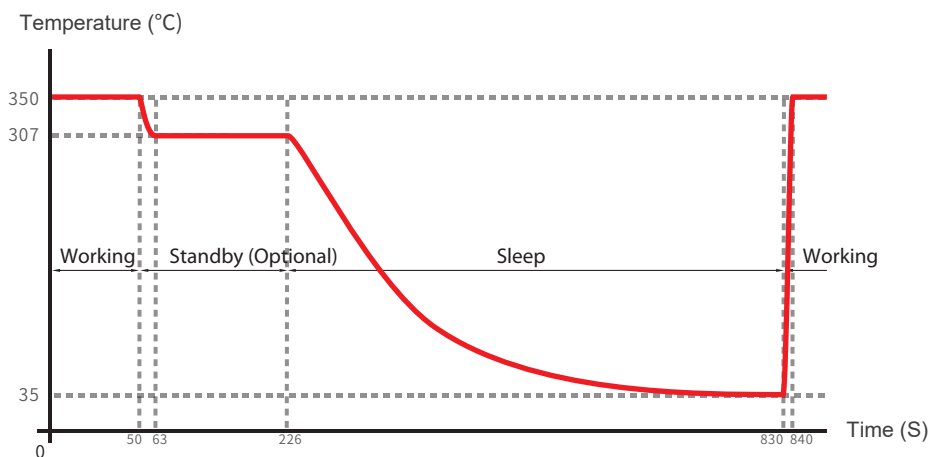

- After put handle on holder, standby function can automatically reduce the temperature of nozzle.
- Once reached standby time, the machine will enter auto sleep mode.
- Once power off, the temperature of nozzle will reduce to room temp.
- After power on, the temperature of nozzle quickly heating up to set temperature.

THE SERVICE LIFE OF NOZZLE CAN BE EXTENDED 5 TIMES AT MOST

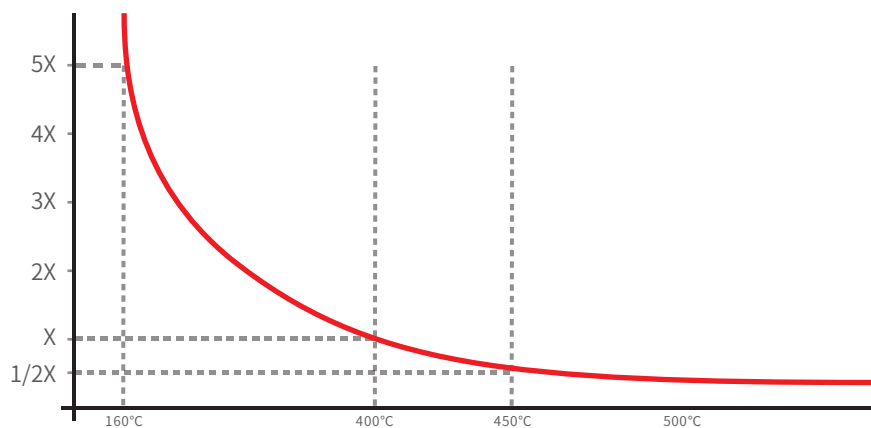

Using the nozzle base on the temperature illustration, the service life of nozzle can be double extended.

The function of auto sleep, could protect nozzle to extend 5 times of service life.

MS-300 **ESD SAFE**

3 In 1 Rework Station



Specification:

Product pictures				
Model	ST-862D	ST-965	APS15-3A	
Power	1000W	65W	56W	
Temperature range	100°C~480°C	80°C~450°C	Ripple and noise	CV \leq 0.5mVrms
Air flow	130L/min(Max),20L/min(Min)		Protection function	OCP(support automatically recovery)/OHP
Heater	Pluggable HR-2102A	Pluggable HS-3065A	USB interface	Fixed 5V output(\pm 5%), maximum 2.1A output(overcurrent protection, stop outputting)
Soldering tip type	Nozzles:4 PCS	T900-0.2IS	Heat-dissipating method	Smart fan control
Working condition	Temp:0°C~40°C Humidity: <80%	Temp:0°C~40°C Humidity: <80%	Working condition	Temp:0~40°C Humidity: <80%
Storage condition	Temp:-20°C~80°C Humidity: <80%	Temp:-20°C~80°C Humidity: <80%	Storage condition	Temp:-20~70°C Humidity: <80%
Dimensions	210x174x150(mm)	210x88x150(mm)	Size	210x80x150(mm)
N.W.	3.34kg	1.97kg	N.W.	2.4kg
Applications	<ul style="list-style-type: none"> • Institutes • Enterprises • Education and practice • Maintenance • Hobby 			

Note: T900 series soldering tip details in page 31,ST-862D nozzles details in page 32.

MS-500 ESD SAFE

3 In 1 Rework Station



Specification:

Product pictures				
Model	ST-862D	ST-1509	APS22-5A	
Power	1000W	150W	125W	
Temperature range	100°C~480°C	80°C~480°C	Ripple and noise	CV ≤ 0.5mVrms
Air flow	130L/min(Max), 20L/min(Min)		Protection function	OCP(support automatically recovery)/OHP
Heater	Pluggable HR-2102A	Integrated	USB interface	Fixed 5V output(±5%), maximum 2.1A output(overcurrent protection, stop outputting)
Soldering tip type	Nozzles:4 PCS	T950-0.1IS	Heat-dissipating method	Smart fan control
Working condition	Temp:0°C~40°C Humidity: <80%	Temp:0°C~40°C Humidity: <80%	Working condition	Temp:0 ~ 40°C Humidity: <80%
Storage condition	Temp:-20°C~80°C Humidity: <80%	Temp:-20°C~80°C Humidity: <80%	Storage condition	Temp:-20~70°C Humidity: <80%
Dimensions	210x174x150(mm)	210x88x150(mm)	Size	210x80x150(mm)
N.W.	3.34kg	3kg	N.W.	2.4kg
Applications	<ul style="list-style-type: none"> • Institutes • Enterprises • Education and practice • Maintenance • Hobby 			

Note: T950 series soldering tip details in page 11, ST-862D nozzles details in page 32.

ST Series Soldering Station

ST-1503/ST-1503D

ESD
SAFE

High Frequency Soldering Station



Features:

- 150W high frequency soldering station with LCD display.
- Max temperature is 600°C.
- Pluggable heater design, easy to replace.
- 3 sets shortcut temperature to simplify.
- Support IR temperature calibration function.
- Support °C and °F switchable.
- Support control the switch on an off of the smoke purifier.
- ST-1503D with RS485 communication interface, support IoT function.

Specification:

Heater HS-3150H

Item No	ST-1503	ST-1503D
Voltage	AC(100V/110V/120V/220V/230V/240) 50/60Hz	
Power	150W	
Temperature range	80°C~600°C	
Soldering tip	T500-4C	
The handle type	SP-H150	
Heater	HS-3150H	
IOT Function	No	Yes
Tip-to-ground impedance	<2Ω	
Tip-to-ground voltage	<2mV	
Standard Packing	Inner box: 290x260x185(mm) N.W.: 5kg G.W.: 5.5kg Carton:4PCS/Carton Size: 305x535x395(mm) N.W.: 22kg G.W.: 23kg	
Applications	<ul style="list-style-type: none"> • High frequency and high power, fast temperature recovery, suitable for soldering big solder joints • Suitable for soldering and desoldering the big solder joints in industrial products • Widely used in the production line of all the kinds of enterprises 	

Note: T500 series soldering tip details in page 17.

IOT Function

ST-1503D

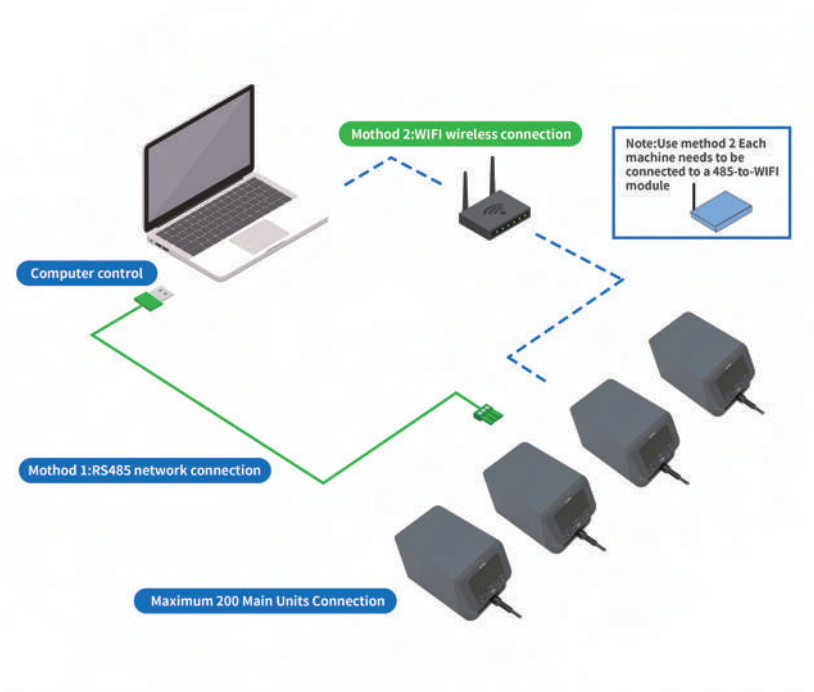

Control smoke purifier function

The diagram shows the ST-1503D connected to an RS485 module, which is then connected to a smoke purifier. A label indicates "Control smoke purifier function".

ST-1503D can control the switch on and off of the smoke purifier.

Intelligent management platform

The soldering station built-in 485 communication module (Wireless communication module can also be installed), can be docked with intelligent management platform software system, Realization: interconnected real-time monitoring, process preservation and copying, data storage and traceability, statistical analysis and management, monitoring and alarm prompts, remote control.

Soldering tips (T500)

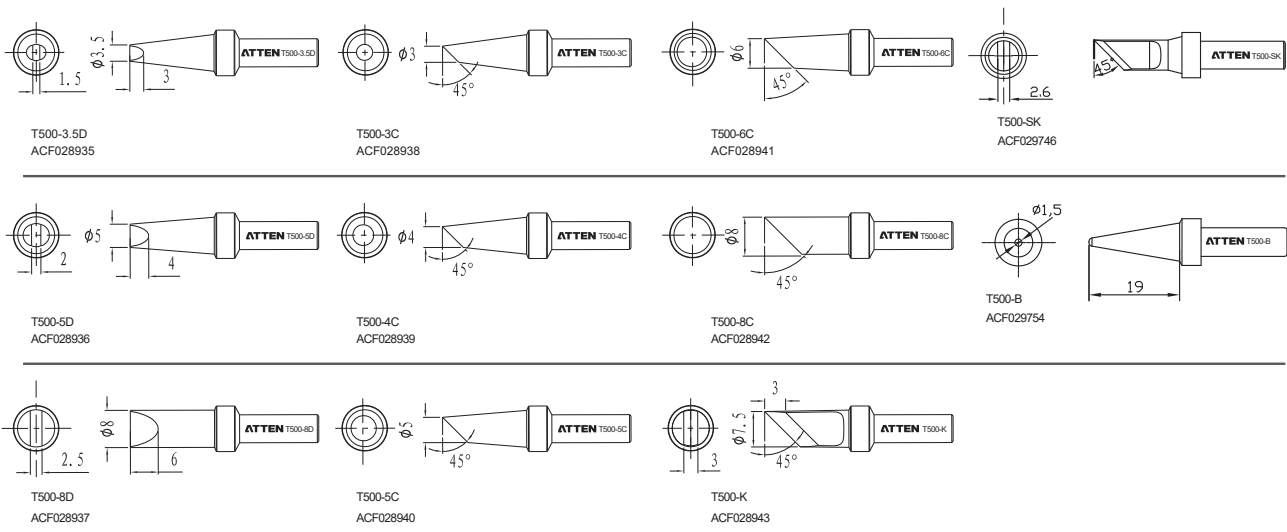

ST-60/ST-80/ST-100



Digital Soldering Station



Features:

- 60W,80W,100W,soldering station with LCD display.
- ST-60 and ST-80 use ceramic haeter.
- ST-100 use sliveralloy heater,fast thermal conductivity.
- 3 sets shortcut temperature to simplify operations.
- Support temp lock, temp calibration function.
- Support °C and °F switchable.
- Smart standby and shutdown function,conserves energy and protect equipment.

Specification:

Product pictures			
Item No	ST-60	ST-80	ST-100
Voltage	AC(100V/110V/120V/220V/230V/240) 50/60Hz		
Power	60W	80W	100W
Temperature range	150°C~450°C	150°C~480°C	150°C~480°C
Temperature Stability	±2°C (in still air, no load)	±2°C (in still air, no load)	±2°C (in still air, no load)
The handle type	SP-60	SP-80	SP-100
Soldering tip type	T900-B	T900-B	T800-0.25I
Heater	60W dual-core ceramic heater HS-3060A	80W four-core ceramic heater HS-3080	100W Sliver alloy heater HS-3100
Package list	Main unit: 1unit Handle set : 1 PCS Iron stand: 1 PCS Manual: 1 PCS AC cord: 1 PCS		
Standard Packing	Inner box: 315x270x152(mm) N.W.: 1.86kg G.W.: 2.2kg Carton: 6PCS/Carton Size: 555x330x480(mm) N.W.: 13.2kg G.W.: 14.3kg	Inner box: 315x270x152(mm) N.W.: 2.3kg G.W.: 2.64kg Carton: 6PCS/Carton Size: 555x330x480(mm) N.W.: 15.84kg G.W.: 16.94kg	Inner box: 315x270x152(mm) N.W.: 2.57kg G.W.: 2.91kg Carton: 6PCS/Carton Size: 555x330x480(mm) N.W.: 17.46kg G.W.: 18.56kg
Applications	<ul style="list-style-type: none"> • Institutes • Enterprises • Education and practice • Maintenance • Hobby 		

Note: T800 series soldering tip details in page 19. T900 series soldering tip details in page 31.

Soldering tips (T800)

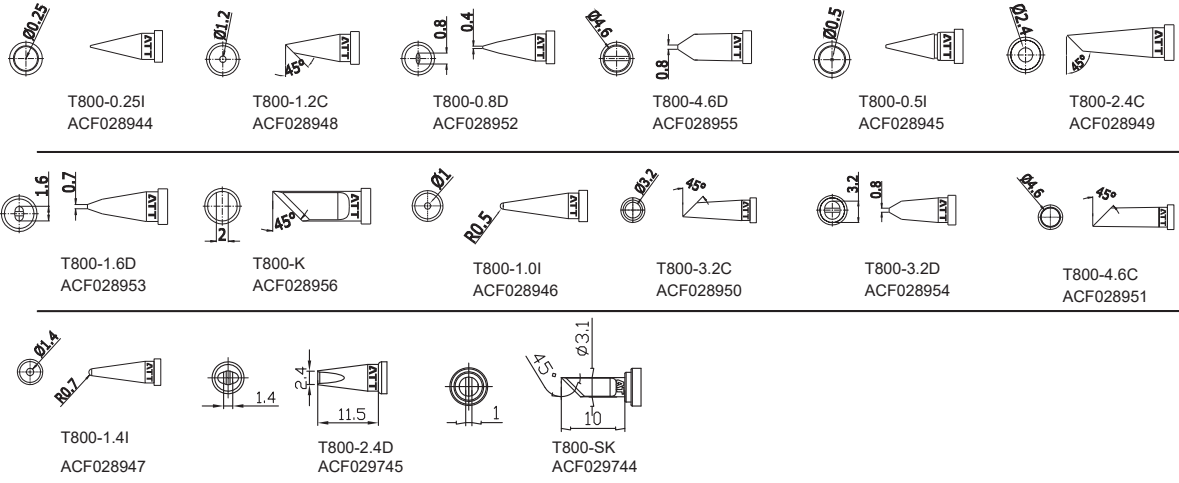

Integrated heater (T990)

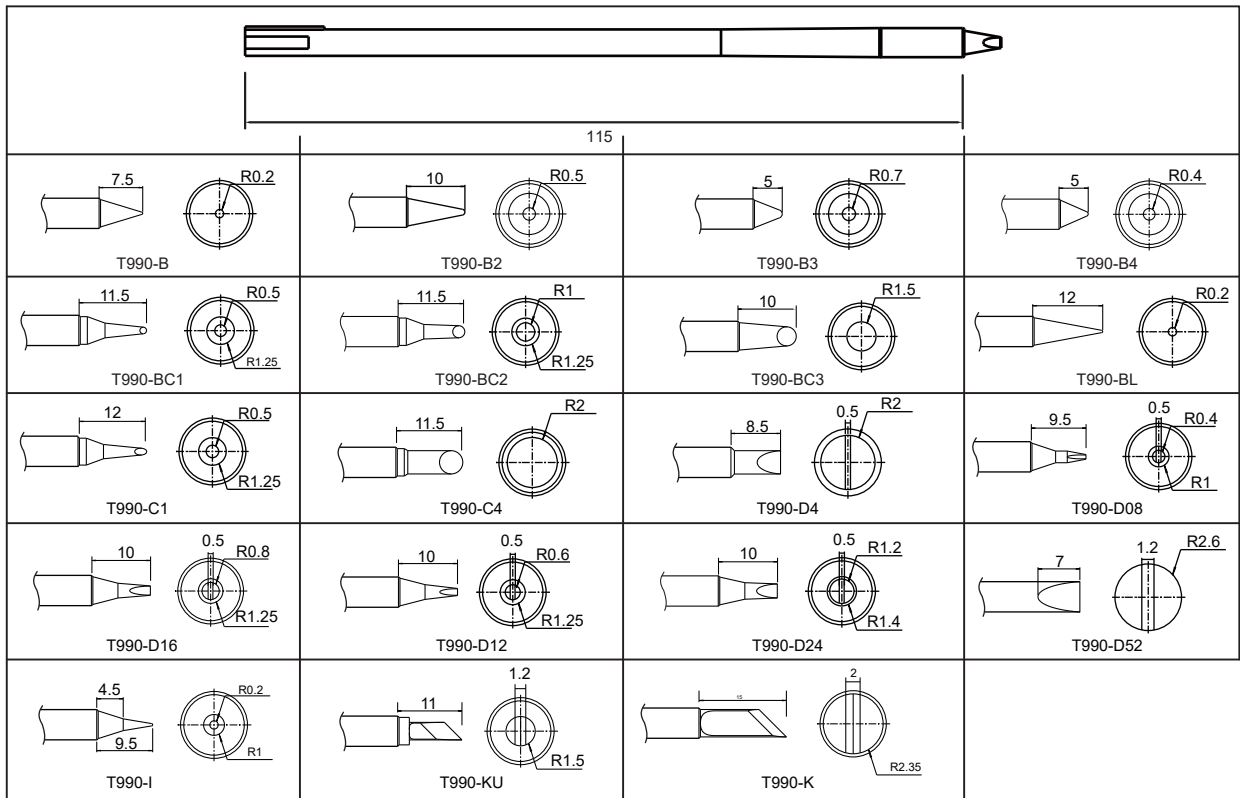

ST-909

Digital Soldering Station



Features:

- 90W soldering station with LCD display.
- Using integrated soldering tips, rapid heating.
- Pluggable heater design, easy to replace.
- 3 sets shortcut temperature to simplify operations.
- Support temp lock,temp calibration.
- Support °C and °F switchable.
- Auto standby function, conserves energy and protect equipment.



Integrated T990-K

Specification:

Model	ST-909
Voltage	AC(100V/110V/120V/220V/230V/240) 50/60Hz
Power	90W
Temperature range	200°C~480°C
Temperature Stability	±2°C (in still air, no load)
The handle type	SP-990
Heater	Integrated heater (T990-K)
Package list	Main unit: 1unit Handle set : 1 PCS Iron stand: 1 PCS Manual: 1 PCS AC cord: 1 PCS Anti-scalding sleeve: 1 PCS
Standard Packing	Inner box: 246x224x142(mm) N.W.: 2.22kg G.W.: 2.5kg Carton: 8PCS/Carton Size: 507x463x309(mm) N.W.: 20kg G.W.: 21kg
Applications	<ul style="list-style-type: none"> ● Production line ● Institutes ● Enterprises ● Education and practice ● Maintenance ● Hobby

Note: T990 series soldering tip details in page 19.

ST-965

Digital Soldering Station



Features:

- 65W soldering station with LCD display.
- Pluggable ceramic heater, easy to replace long use life.
- 3 sets shortcut temperature to simplify operations.
- Support temp lock,temp calibration.
- Support °C and °F switchable.
- Auto sleep and shutdown funtion, conserves energy and protect equipment.
- Password-protected function to preserve settings



Pluggable four-core wire heater HS-3065A

Specification:

Model	ST-965		
Voltage	AC(100V/110V/120V/220V/230V/240) 50/60Hz		
Power	65W		
Temperature range	80°C~480°C		
Temperature Stability	±2°C (in still air, no load)		
The handle type	SP-65		
Heater	Pluggable four-core wire heater HS-3065A		
Soldering tip type	T900-B		
Package list	Main unit: 1unit Handle set : 1 PCS	Iron stand: 1 PCS AC cord: 1 PCS	Manual: 1 PCS
Standard Packing	Inner box: 282x210x187(mm) N.W.: 2.62kg G.W.: 2.91kg Carton: 8PCS/Carton Size: 585x435x400(mm) N.W.: 23.2kg G.W.: 24.5kg		
Applications	<ul style="list-style-type: none"> • Production line • Education and practice 	<ul style="list-style-type: none"> • Institutes • Maintenance 	<ul style="list-style-type: none"> • Enterprises • Hobby

Note: T900 series soldering tip details in page 31.

ST-1509



Intelligent Soldering Station



heater

Features:

- 150W high power soldering station with LCD display.
- Using integrated soldering tips, rapid heating.
- Pluggable heater design, easy to replace.
- 3 sets shortcut temperature to simplify operations.
- Auto standby and sleep function, conserves energy and protect equipment.
- Support temp lock,temp calibration function.
- Support °C and °F switchable.
- Password-protected function to preserve settings.
- Compatible with Y950/Y9130/Y9150/N9100 handles.

Specification:

Item No	ST-1509			
Voltage	AC(100V/110V/120V/220V/230V/240) 50/60Hz			
Power	150W			
Temperature range	80°C~480°C/176°F~896°F			
Temperature accuracy	±10°C			
The handle type	Y950 /Y9130 /Y9150 /N9100 optional			
Soldering tip/Heater	T950-0.1IS T950-2.0SK / T9130-1.0I T9130-K / T9150-K T9150-B / T9100-0.5I optional			
Soldering stand	S-13			
Package list	Main unit: 1unit AC cord: 1 PCS	Iron Stand: 1PCS integrated heater with tip: 2 PCS	Manual: 1 PCS	Iron Handle Set: 1PCS
Standard Packing	Inner box: 282x210x187(mm) N.W.: 3kg G.W.: 3.3kg Carton: 6PCS/Carton Size: 435x300x580(mm) N.W.: 19.8kg G.W.: 20.8kg			
Applications	<ul style="list-style-type: none"> • Production line • Education and practice 	<ul style="list-style-type: none"> • Institutes • Maintenance 	<ul style="list-style-type: none"> • Enterprises • Hobby soldering 	

Note: Integrated heater details in page 11-12.(T950/T9100/T9130/T9150)

ST-2090D

Multifunctional Soldering Station



Features:

- 80W soldering station with LED display.
- 2 in 1 design of soldering station and soldering iron stand.
- Using ceramic heater.
- Souppt temp lock function.
- Support °C and °F switchable.
- Auto standby and sleep funtion, conserves energy and protect equipment.



Four core Ceramic heater HS-2065A

Model	ST-2090D		
Voltage	110/240V AC		
Power	80W		
Temperature range	80°C~480°C		
Temperature Stability	±2°C (in still air, no load)		
Temperature unit	°C/°F		
Soldering tip type	T900-B		
Package list	Main unit (including machine, power cable and handle)x1pc Soldering wire holder x 1pc User manual x 1pc		
Standard Packing	Inner box: 200x180x125(mm) N.W.: 0.7kg G.W.: 0.91kg Carton: 12PCS/carton Size: 415x375x390(mm) N.W.: 11kg G.W.: 11.8kg		
Applications	<ul style="list-style-type: none"> • Production line • Education and practice 	<ul style="list-style-type: none"> • Institutes • Maintenance 	<ul style="list-style-type: none"> • Enterprises • Hobby

Note: T900 series soldering tip details in page 31.

AT Series Soldering Station

AT-937A **ESD SAFE**

ESD Safe Constant Temperature Controllable Soldering Station



AT-989 **ESD SAFE**

ESD Safe Constant Temperature Controllable Soldering Station



AT989D **ESD SAFE**

ESD Safe Constant Temperature Controllable Digital Soldering Station



Features:

- MCU controlled temperature calibration with PID system equipped.
- The heater using low voltage AC source to ensure the antistatic and no leakage, no interference.
- Legerity handle suitable for long time operation.
- Unique temperature locks setting to avoid adjusting temperature.

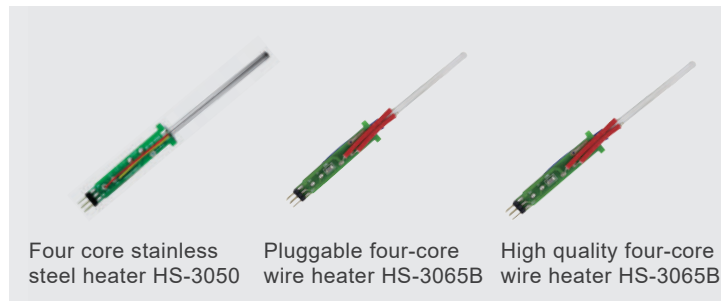

Specification:

Item No	AT-937A	AT-989	AT-989D
Voltage	AC(100V/110V/120V/1220V/230V/240) 50/60Hz		
Power	65W	65W	65W
Temperature range	200°C~480°C	200°C~480°C	80°C~480°C
Temperature stability	±2°C(in still air,no load)	±2°C(in still air,no load)	±2°C(in still air,no load)
The handle type	AP-65	AP-65A	AP-65A
Soldering tip type	T900-B	T900-B	T900-B
Heater	Four core stainless steel heater	High quality four-core wire heater	High quality four-core wire heater
Package list	Main unit: 1unit Handle set : 1 PCS	Iron stand: 1 PCS AC cord: 1 PCS	Manual: 1 PCS Cleaning sponge: 1 PCS
Standard Packing	Inner box: 250x210x134(mm) N.W.: 1.6kg G.W.: 1.7kg Carton: 12Carton/Carton Size: 515x435x425(mm) N.W.: 20.4kg G.W.: 21.4kg		Inner box: 250x210x134(mm) N.W.: 1.73kg G.W.: 1.96kg Carton: 12Carton/Carton Size: 515x435x425(mm) N.W.: 23.52kg G.W.: 24.52kg
Applications	<ul style="list-style-type: none"> • Production line • Education and practice 	<ul style="list-style-type: none"> • Institutes • Maintenance 	<ul style="list-style-type: none"> • Enterprises • Hobby

Note: T900 series soldering tip details in page 31.

ST Series Hot Air Station



ST-862D

**ESD
SAFE**

Intelligent Hot Air Rework Station



Features:

- LCD display screen making control visualization.
- Temperature unit switching function.
- Temperature locking ,timed work function.
- MCU controlled temperature calibration,compensation for constant working .
- Strong air volume with brushless fan.
- Easy to replace with pluggable heater.
- Convertible with straight air and spiral air.
- Auto-sleep function.

A2600 nozzle converter
for all nozzles of AT-852D,
AT-850D and AT-8502D



Specification:

Model	ST-862D			
Voltage	AC(100V/110V/120V/220V/230V/240) 50/60Hz			
Power	1000W			
Temperature range	100°C~480°C			
Air flow	20~130L/min			
Beep alarm function	Available			
The handle type	SP-102B			
Package list	Main unit: 1 unit Gun holder : 1 PCS	Hot air gun: 1 PCS AC cord: 1 PCS	Manual: 1 PCS Nozzles: 4 PCS	Nozzle converter: 1 PCS
Standard Packing	Inner box: 340x290x187(mm) N.W.: 4kg G.W.: 4.39kg Carton: 6PCS/carton Size: 600x360x580(mm) N.W.: 26.34kg G.W.: 27.5kg			
Applications	<ul style="list-style-type: none"> • Production line • Education and practice 	<ul style="list-style-type: none"> • Institutes • Maintenance 	<ul style="list-style-type: none"> • Enterprises • Hobby 	

Note: Nozzles details in page 32.

ST-8800D **ESD SAFE**

Intelligent Hot Air Rework Station



A-2000
nozzle converter for all
nozzles of AT-852D,
AT-850D and AT-8502D



A-2131



A-2104



A-2102



A-2105

Features:

- 800W hot air rework station with LCD display.
- Built-in brushless fan, long service life and low noise.
- 3 set shortcut air volume/temperature to simplify operations.
- Support temp lock,temp calibration.
- Support °C and °F switchable.
- Auto standby and sleep function, conserves energy and protect equipment.
- Password-protected function to preserve settings.
- With 10~900s timing function.
- Cold air function to cool components.
- Cooling automatic function(standby),effectively protects the life span of heating core and handle.

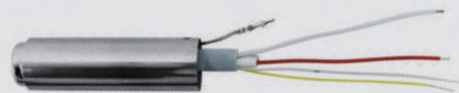

Heater HR-2700A

Specification:

Item No	ST-8800D			
Voltage	AC(100V/110V/120V/220V/230V/240) 50/60Hz			
Power	800W			
Temperature range	100°C~500°C			
Air flow	30-120L/min			
Standby heater cooling function	Support			
Beep alarm function	Available			
Package list	Main unit: 1 unit Gun holder : 1PCS	Hot air gun: 1 PCS AC cord: 1 PCS	Manual: 1 PCS Nozzles: 4 PCS	Nozzle converter: 1 PCS
Standard Packing	Inner box: 302x175x187(mm) N.W.: 1.66kg G.W.: 1.94kg Carton: 9PCS/carton Size: 545x320x580(mm) N.W.: 17.46kg G.W.: 18.5kg			
Applications	<ul style="list-style-type: none"> • Production line • Education and practice 	<ul style="list-style-type: none"> • Institutes • Maintenance 	<ul style="list-style-type: none"> • Enterprises • Hobby 	

Note: Nozzles details in page 32.

AT Series Hot Air Station

AT852D

**ESD
SAFE**

500W Hot Air Rework Station With LED Display



AT850D

**ESD
SAFE**

500W Hot Air Rework Station With LED Display



Features:

- Closed-loop and MCU zero crossing design for achieving fast heating-up, accurate and stable control.
- Knob control to adjust the air volume / temperature.
- High power diaphragm pump with high pressure.
- Patented heater for obtaining fast heating-up and extending lifespan.
- Intelligent cooling system and deferred power-off function.
- Automatic cooling function(standby),effectively protects the life span of heating core and handle.
- Support standby and temp calibration function.



Specification:

Model	AT852D	AT850D
Voltage	AC(100V/110V/120V/220V/230V/240) 50/60Hz	
Power	550W	550W
Temperature range	100°C~500°C	100°C~500°C
Air flow	23L/min	23L/min
The handle type	AP-550B+	AP-550B+
Pump	Diaphragm pump	High power diaphragm pump
Timing function	No function	20~600s
Noise	<50dB(A)	<50dB(A)
Package list	Main Unit: 1 PCS Hot Air Gun: 1 PCS Manual: 1 PCS Gun Holder: 1 PCS AC Cord: 1 PCS Nozzle: 2 PCS	Main Unit: 1 PCS Hot Air Gun: 1 PCS Manual: 1 PCS Gun Holder: 1 PCS AC Cord: 1 PCS Nozzle: 4 PCS
Standard packing	Inner box: 330x272x195(mm) N.W.: 3.58kg G.W.: 3.77kg Carton: 6PCS/carton Size: 560x350x615(mm) N.W.: 22.62kg G.W.: 23.8kg	Inner box: 330x272x195(mm) N.W.: 3.58kg G.W.: 3.77kg Carton: 6PCS/carton Size: 560x350x615(mm) N.W.: 22.62kg G.W.: 23.8kg
Applications	<ul style="list-style-type: none"> • Production line • Enterprises • Maintenance 	<ul style="list-style-type: none"> • Institutes • Education and practice • Hobby

Note: Nozzles details in page 32.

ST-8902D

2 In 1 Hot Air Rework Station



Features:

- Hot air station and soldering station 2 in 1 design, saving working space.
- Hot air station: 1300W, rapid heating and high efficiency.
- Soldering station: 90W, rapid heating and temperature recovery.
- LCD display, support display accurate temperature & airflow.
- Provide 3 sets shortcut temperature to avoid frequent settings.
- Use brushless fan, and the air volume is soft and adjustable.
- Designed with intelligent standby and automatic sleep functions.
- Slender and comfortable handle design, ensure long-time holding work.
- Support °C and °F switchable.
- Temperature lock function, ensure constant temperature work.
- Software temperature compensation function, more accurate and convenient.

Specification:

Item No	ST-8902D	
Voltage	AC(100V/110V/120V/220V/230V/240) 50/60Hz	
Name	Hot air station	Soldering station
Power	1300W(230V AC) 1000W(110V AC)	90W
Temperature range	100°C~500°C/212°F~932°F	200°C~500°C/392°F~932°F
Temp stability	±5°C	±2°C
Air flow	20~130L/min	
The handle type	SP-202E	SP-990
Package list	Main unit: 1 unit Hot air gun: 1 PCS Manual: 1 PCS Iron Handle Set: 1PCS Gun Holder : 1 PCS AC cord: 1 PCS Nozzles: 3 PCS Iron Stand: 1 PCS Ground wire:1 PCS Anti-scalding sleeve: 1 PCS	
Standard Packing	Inner box: 340x305x195(mm) N.W.: 4.8kg G.W.: 5.23kg Carton: 4PCS/carton Size: 625x355x415(mm) N.W.: 20.92kg G.W.: 21.92kg	
Applications	<ul style="list-style-type: none"> • Thermoplastic soldering • Education and practice 	<ul style="list-style-type: none"> • On-site soldering for PVC/PE/PP/PVDF etc. • Maintenance

Note: Integrated heater(T990) in page 19. Nozzles details in page 33.

ST-8802



2 In 1 Hot Air Rework Station



High quality four-core wire heater HS-3060

heater HR-2700A

Features:

- Hot air station and soldering station 2 in 1 design, saving working space.
- Hot air station: 800W, rapid heating and high efficiency.
- Soldering station: 65W, rapid heating and temperature recovery.
- LCD display, support display accurate temperature & airflow.
- Built-in brushless fan, long service life and low noise.
- 3 set shortcut air volume/temperature to simplify operations.
- Support temp lock,temp calibration function.
- Support °C and °F switchable.
- Auto standby and sleep function, conserves energy and protect equipment.
- Password-protected function to preserve settings.
- With 10~900s timing function.
- Cold air function to cool components.

Specification:

Model	ST-8802			
Voltage	AC(100V/110V/120V/220V/230V/240) 50/60Hz			
Name	Hot air station		Soldering station	
Total Power	800W		65W	
Temp range	100°C~500°C/212°F~932°F		80°C~480°C/176°F~896°F	
Temp stability	±5°C		±2°C	
Air flow	120L/min			
The handle type	AP-800B		SP-65A	
Soldering tip			T900-0.2SI	
Package list	Main unit: 1 unit Gun Holder : 1 PCS	Hot air gun: 1 PCS AC cord: 1 PCS	Manual: 1 PCS Nozzles: 4 PCS	Iron Handle Set: 1PCS Iron Stand: 1PCS
Standard Packing	Inner box: 295x248x188(mm) N.W.: 3.2kg G.W.: 3.67kg Carton: 6PCS/carton Size: 515x310x595(mm) N.W.: 22.02kg G.W.: 23.1kg			
Applications	<ul style="list-style-type: none"> • Institutes • Maintenance 	<ul style="list-style-type: none"> • Enterprises • Hobby 	<ul style="list-style-type: none"> • Education and practice 	

Nozzles details in page 32.

AT8502D

**ESD
SAFE**

2 In 1 Hot Air Rework Station



Features:

- Hot air station and soldering station 2 in 1 design, saving working space.
- Hot air station: 550W, rapid heating and high efficiency.
- Soldering station: 50W, rapid heating and temperature recovery.
- LCD display, support display accurate temperature & airflow.
- Diaphragm pump with high pressure make it suitable for various nozzles.
- 3 set shortcut air volume/temperature to simplify operations.
- Support °C and °F switchable.
- Support temp lock,temp calibration.
- Intelligent cooling system and deferred power-off function.
- Cold air function to cool components.
- Support standby and temp calibration function.

Specification:

Item No	AT-8502D			
Voltage	AC(100V/110V/120V/220V/230V/240) 50/60Hz			
Total Power	700W			
Name	Soldering station		Hot air station	
Power	50W		550W	
Temperature range	200°C~480°C/392~896°F		100°C~500°C/212~932°F	
Pump			Diaphragm	
Air flow			23L/min	
The handle type	AP-50		AP-551B	
Soldering tip	T900-B			
Noise			<50dB(A)	
Package list	Main Unit: 1 unit Gun Holder: 1 PCS	Hot Air Gun: 1 PCS AC Cord: 1 PCS	Manual: 1 PCS Nozzle: 4 PCS	Iron Handle Set: 1 PCS Iron Stand: 1 PCS
Standard packing	Inner box: 354x329x194(mm) N.W.: 4.85kg G.W.: 5.41kg Carton: 4PCS/carton Size: 670x370x415(mm) N.W.: 21.64kg G.W.: 22.85kg			
Applications	<ul style="list-style-type: none"> • Thermoplastic soldering • Education and practice 		<ul style="list-style-type: none"> • On-site soldering for PVC/PE/PP/PVDF etc. • Maintenance 	

Note: Soldering tips (T900) in page 19. Nozzles details in page 33.

Soldering tips (T900)

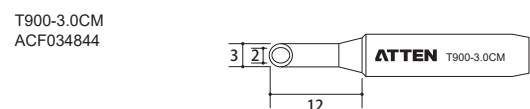
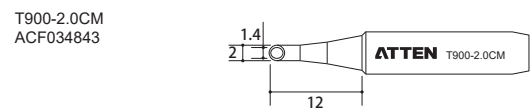
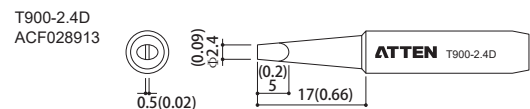
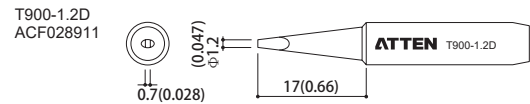
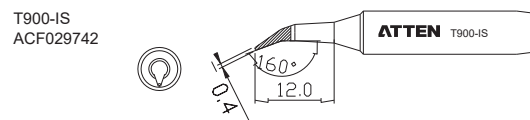
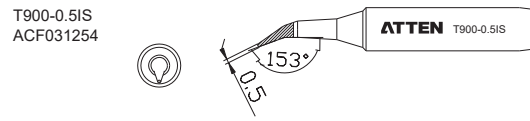
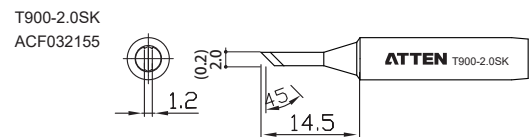
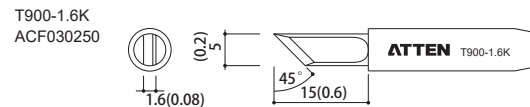
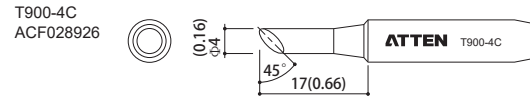
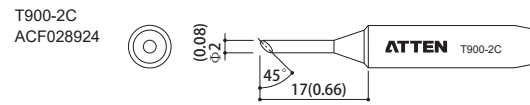
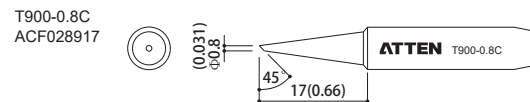
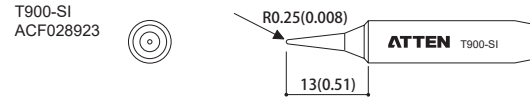
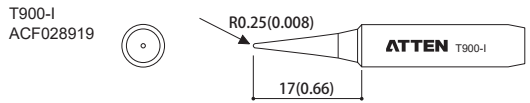
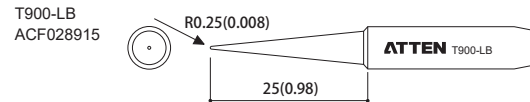
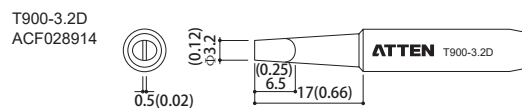
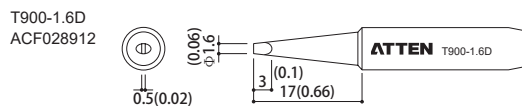
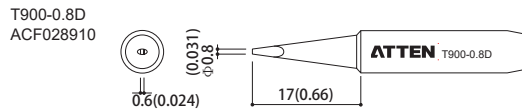
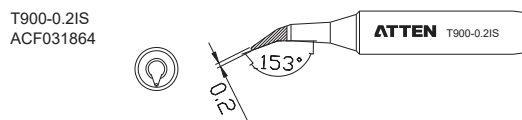
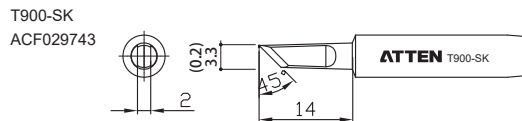
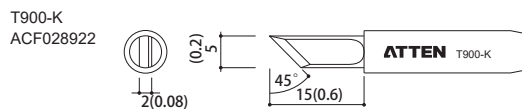
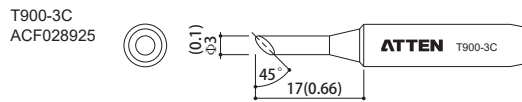
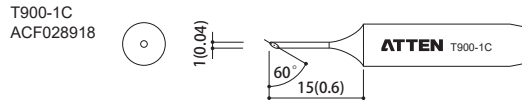
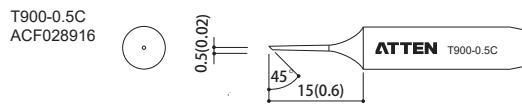
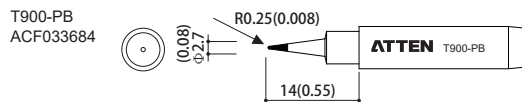
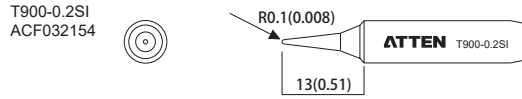
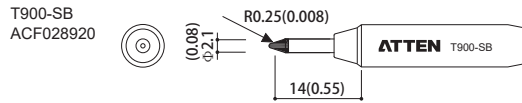
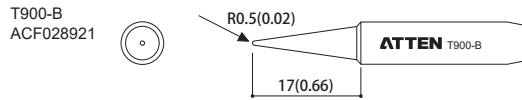

Nozzles (Applicable models: AT8586 AT858D+ ST-8800D ST-8802)

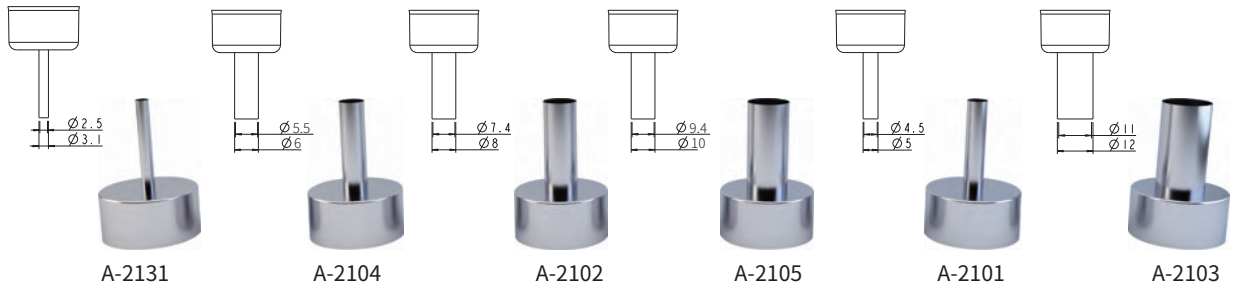



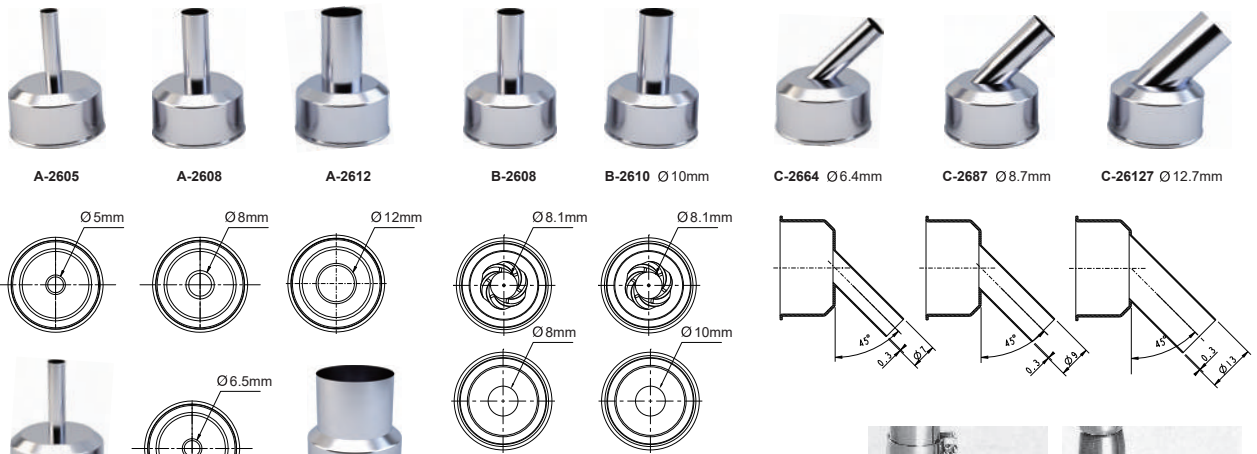



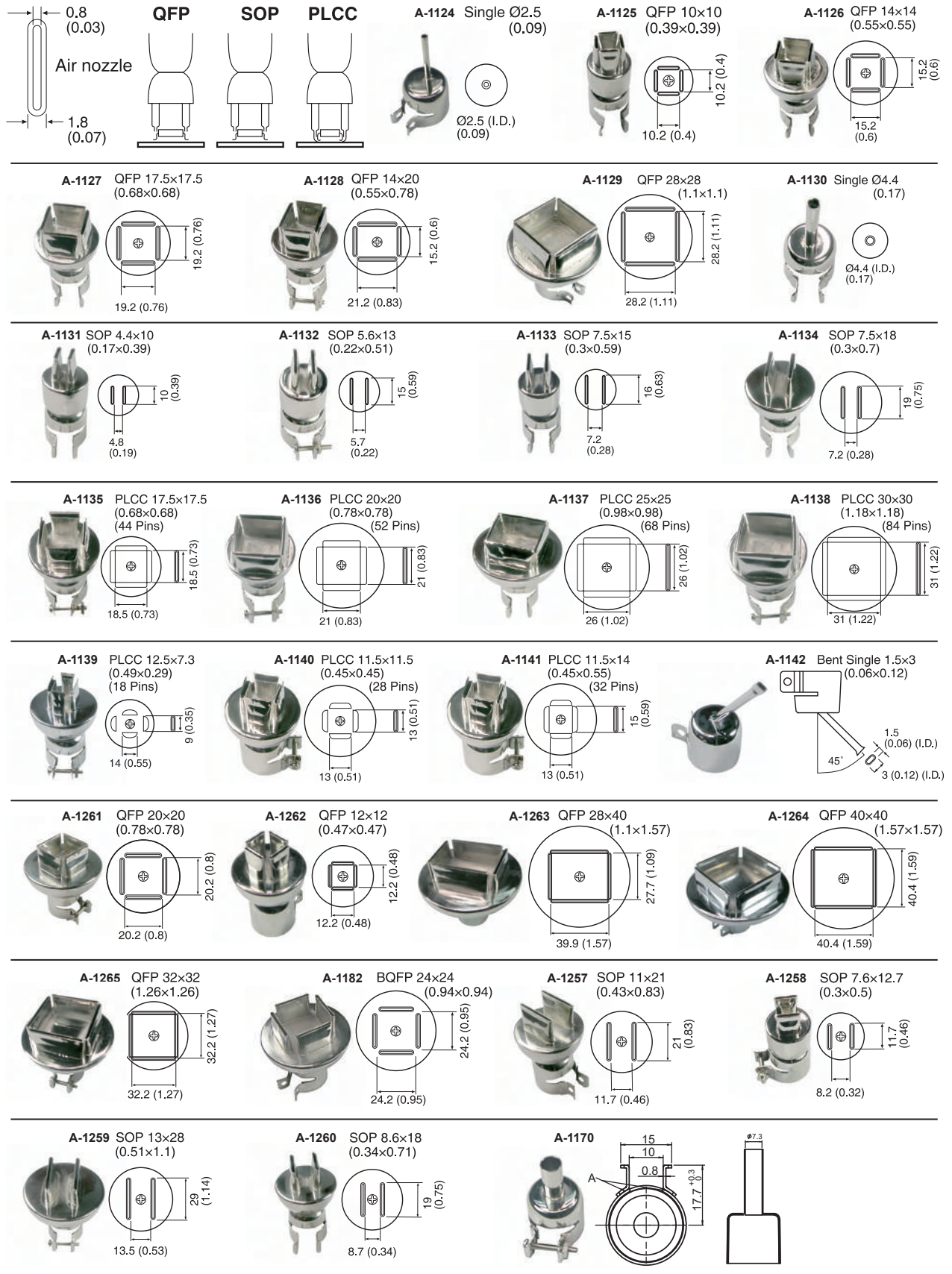

















Nozzles (Applicable models: ST-862D)



Nozzles (Applicable models: AT850 AT852 AT8502)



Handle of Soldering station and Hot air rework station

Category	Item No	Pictures	Models Available
The soldering station handle	AP-50		AT-937/AT-8586/AT-8502D ROHS
	AP-65		AT-937A(Pluggable heating element) ROHS
	AP-65A		AT-989/AT-989D ROHS
	SP-65A		ST-8802 ROHS
	SP-60		ST-60 ROHS
	SP-80		ST-80 ROHS
	SP-100		ST-100 ROHS
	SP-990		ST-909 ROHS
	AP-60		AT-938D ROHS
	AP-80		AT-980E ROHS
	SP-65		ST-965(Pluggable heating element) ROHS
	SP-90B		ST-2090D ROHS
	Y-950		ST-1509(Integrated) 50W ROHS
	Y-9130		ST-1509(Integrated) 130W ROHS
	Y-9150		ST-1509(Integrated) 150W ROHS
	N-9100		ST-1509(Integrated Tweezers) 100W ROHS
	SP-H150		ST-1503 ST-1503D ROHS
The hot air rework station handle	AP-700B		AT-858D+/AT-8586 ROHS
	AP-550B+		AT-850D/AT-852D ROHS
	AP-551B		AT-8502D ROHS
	AP-552B		MS-900 ROHS
	AP-102B		ST-862D ROHS
	AP-800B		ST-8800D/ST-8802 ROHS
	SP-202E		ST-8902D ROHS
	SP-202D		GT-1028 ROHS

Soldering Iron

GT-2010+

USB Soldering Iron



Features:

- Portable design. Can be carried after handle cap inserted if it's hot.
- USB standard interface of power bank or adapter supply it with electricity.
- Contact temperature-sensed design, more sensitive and more accurate sensing.
- Full silicone handle cable, anti-scalding and anti-winding.
- Using integrated soldering tips, rapid heating.
- Pluggable heater design, easy to replace.
- 3 sets of shortcut temperature, fast and convenient.
- Auto sleep function, conserves energy and protect equipment.

Model	GT-2010+		
Voltage	5V DC		
Power	10W		
Temperature range	100°C ~ 450°C		
Temperature Stability	±2°C (in still air, no load)		
Heater	10W integrated heater (T10-0.5I)		
Temperature offset range	±50°C/±90°F		
Auto-sleep mode	Support		
Package list	Manual: 1PCS Certificate of quality: 1PCS USB Soldering iron : 1 Unit Soldering iron stand: 1PCS		
Standard Packing	Inner box: 310x150x88(mm) N.W.: 0.56kg G.W.: 0.6kg Carton: 18pcs/carton Size: 465x325x565(mm) N.W.: 10kg G.W.: 10.8kg		
Applications	<ul style="list-style-type: none"> • Production line • Education and practice 	<ul style="list-style-type: none"> • Institutes • Maintenance 	<ul style="list-style-type: none"> • Enterprises • Hobby

Note: T10 series soldering tip details in page 37.

ST Series Soldering Iron



Features:

- Automatic sleep after 10 minutes inactivity.
- Automatic shut down after 20 minutes inactivity.
- Build in PID system.
- Shortcut temperatures adjust by button.
- LCD / LED display design.
- ESD safe
- Soldering tip designed separate from heater and using exchangeable T2080, T2150, T900 series to save use-cost.



Soldering iron stand S-11 (Optional)

Specification:

Pictures					
Item No	ST-2065D	ST-2080	ST-2080D	ST-2150	ST-2150D
Power	65W	80W	80W	150W	150W
Temperature range	80°C~480°C	5set adjustment	80°C~480°C	5set adjustment	80°C~480°C
Temperature stability	±2°C	±2°C	±2°C	±2°C	±2°C
Heater	Four-core PTC heater HS-2065D	Four-core PTC heater HS-2080	Four-core PTC heater HS-2080	Four-core PTC heater HS-2150	Four-core PTC heater HS-2150
Heating indication	Blue LED	Blue LED	Blue LED	Blue LED	Blue LED
Temperature unit	°C/°F	°C	°C/°F	°C	°C/°F
Display method	LCD	LED	LCD	LED	LCD
Soldering tip	T900-B	T2080-B	T2080-B	T2150-B	T2150-B
Package list	Soldering Iron: 1 Unit Iron holder: 1 PCS Manual: 1 PCS				
Standard Pcking	Inner box: 55x46x290(mm) N.W.: 0.21kg G.W.: 0.25kg		Carton:50pcs/carton Size:490x305x335(mm) N.W.: 12.5kg G.W.: 13.8kg		

Note: T2080, T2150 series soldering tip details in page 37, T900 series soldering tip details in page ,31.

Integrated heater (10W)

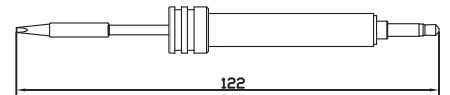

<p>T10-1.3D ACF030015</p>	<p>T10-1.2C ACF030014</p>	<p>T10-2.2D ACF030016</p>	<p>T10-3.0D ACF030017</p>	<p>T10-0.5I ACF030018</p>	<p>T10-K ACF030019</p>
-------------------------------	-------------------------------	-------------------------------	-------------------------------	-------------------------------	----------------------------

Soldering tips (T2080)

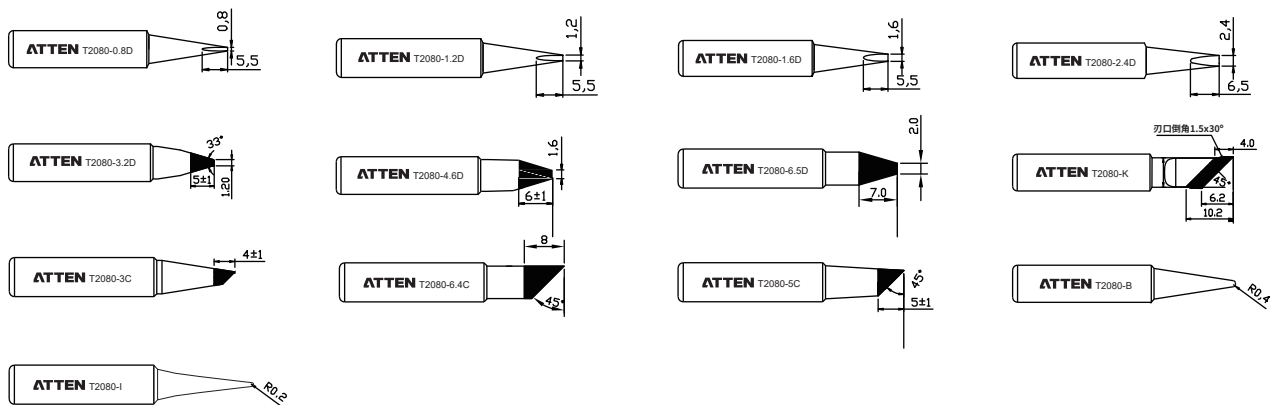

Soldering tips (T2150)

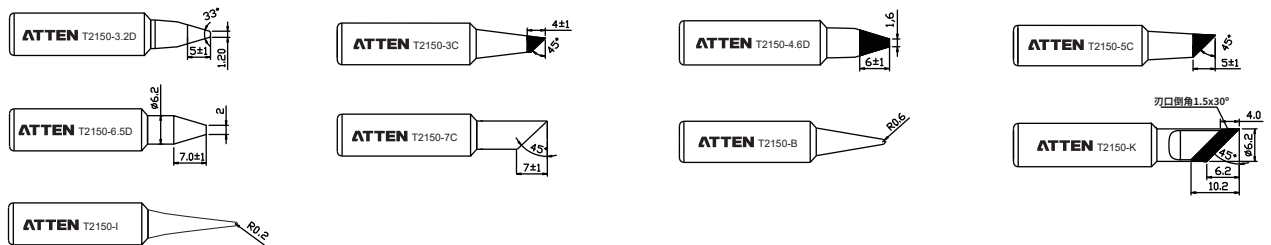

Fume Extractor



ST-1101



ST-1101D



ST-1202



ST-1202D

Specification:

Model	ST-1101	ST-1101D	ST-1202	ST-1202D
Voltage	AC(100V/110V/120V/220V/230V/240) 50/60HZ (Optional)			
Power	160W	160W	180W	180W
Work position	1	1	2	2
System flow(including filtrating equipment)	240m³/H(±10%)	240m³/H(±10%)	150m³/H*2(±10%)	150m³/H*2(±10%)
Filtrarion efficiency (0.3 micron)	99.97%	99.97%	99.97%	99.97%
RS485 interface	No	Yes	No	Yes
Overall dimension(host)	465x250x480mm	465x250x480mm	465x250x480mm	465x250x480mm
Weight	17kg	17kg	18.2kg	18.2kg

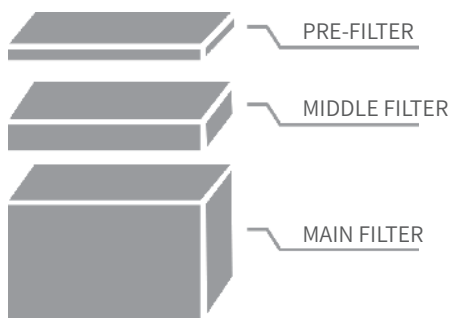

- 1.The relatively dense side of the pre-filterfaces down.
- 2.The sequence of filters shall be subject to right diagram.
Disorganization is strictly forbidden.
- 3.Suggestions on replacement cycle of filters:
 - a.PRE-FILTER 10-15 days
 - b.MIDDLE FILTER 3-6 months
 - c.MAIN FILTER 6-9 months
 (Remark: The actual replacement cycles of filtersshall be subject to the pollution levels of differentsites.)

Communication function

The host is equipped with RS485 interface, which can be connected with the computer, soldering station/hot air station for synchronous operation command.



The communication address code of the soldering station and the smoke purifier needs to be consistent, if they need to connect and work synchronously.

The communication address code of the PC and the smoke purifier needs to be consistent, if they need to connect and work synchronously.

Connection mode with PC

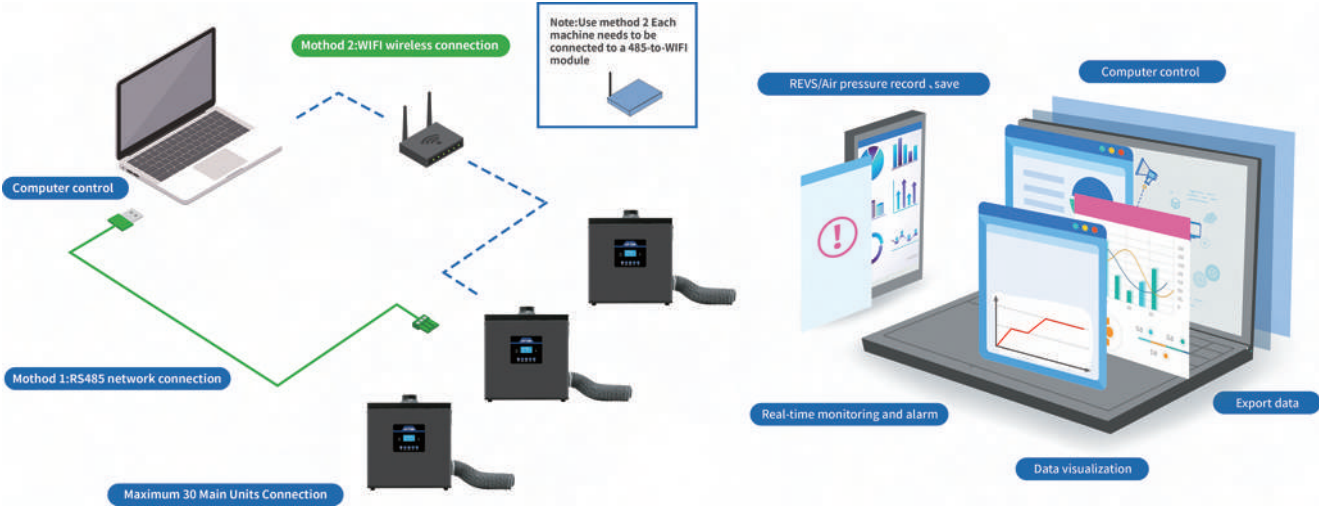

Test report

检测报告
Report No. W1222384889PC1211

二、工作环境空气质量检测结果

注: Test results for air in the workplace

测点位置 Test Point	检测项目 Testing Items	等效噪声等效声压级 Equivalent Continuous Sound Pressure Level			等效剂量等效声压级 Equivalent Energy Sound Pressure Level		
		C _{Leq}	C _{max}	C ₁₀	PC-AELA	PC-EELA	MAC
1 焊锡站旁噪音 Before the Solder station is turned on	等效噪声 C _{Leq}	33.3	4	4	24	4	4
	最大噪声 C _{max}	58.11	1	2	7	6	7
	10%超标率 C ₁₀	49.86	1	0.03	7	0.09	7
2 焊锡站旁噪音 After the Solder purifier is turned on	等效噪声 C _{Leq}	40.44	1	4	7	24	7
	最大噪声 C _{max}	59.11	1	2	7	6	7
	10%超标率 C ₁₀	48.13	1	0.03	7	0.09	7
3 焊锡站旁噪音 The Solder purifier Exhaust Port	等效噪声 C _{Leq}	40.44	1	4	7	24	7
	最大噪声 C _{max}	59.11	1	2	7	6	7
	10%超标率 C ₁₀	48.13	1	0.03	7	0.09	7

注:
① C_{Leq}: 等效连续A声级等效声压级
② C_{max}: 最大声压级
③ C₁₀: C_{Leq} 声压级中声压级超过限值的时间占10%的时间
④ PC-AELA: 等效剂量A声级等效声压级
⑤ PC-EELA: 等效剂量等效声压级
⑥ MAC: 最大允许声级

检测报告
Report No. W1222384889PC1211

注: Test results for air in the workplace

注: Test results for air in the workplace

① C_{Leq}: 等效连续A声级等效声压级
② C_{max}: 最大声压级
③ C₁₀: C_{Leq} 声压级中声压级超过限值的时间占10%的时间
④ PC-AELA: 等效剂量A声级等效声压级
⑤ PC-EELA: 等效剂量等效声压级
⑥ MAC: 最大允许声级

⑦ The daily accumulated exposure time of the spot is less than 1 hour, and C_{max} is not calculated.
⑧ The daily accumulated exposure time of the spot is less than 1 hour, and C_{max} is not calculated.
⑨ The daily accumulated exposure time of the spot is less than 1 hour, and C_{max} is not calculated.
⑩ The daily accumulated exposure time of the spot is less than 1 hour, and C_{max} is not calculated.
⑪ The daily accumulated exposure time of the spot is less than 1 hour, and C_{max} is not calculated.
⑫ The daily accumulated exposure time of the spot is less than 1 hour, and C_{max} is not calculated.

Heat Gun



ST-2308



ST-2308D



ST-2308DX

Model	ST-2308	ST-2308D	ST-2308DX
Voltage	AC(100V/110V/120V/220V/230V/240) 50/60HZ (Optional)		
Power	2100W	2100W	2300W
Temperature range	50-650°C	50-650°C	50-650°C
Air flow	I:200L/min II:500L/min	200-500L/min	200-500L/min
Remarks	LED, Adjustable Temp, Brush fan	LCD, Adjustable Temp, Brush fan	LCD, Adjustable Temp, Brushless fan
Standard Packing	Heat gun: 1unit Nozzle: 1 PCS User manual: 1 PCS		
Product size	280x82x210mm	280x82x210mm	290x82x210mm
N.W.	1.07kg	1.07kg	1.13kg
G.W.	1.26kg	1.26kg	1.32kg

Heat Gun Nozzles



T8230-23



T8230-15



T8230-85



T8230-67



T8230-43



T8230-49

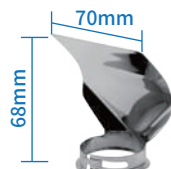

T8230-68

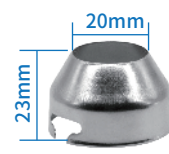

T8230-20

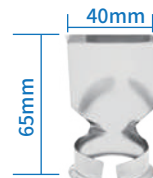

T8230-40



T8230-65

Temperature tester ST-1090

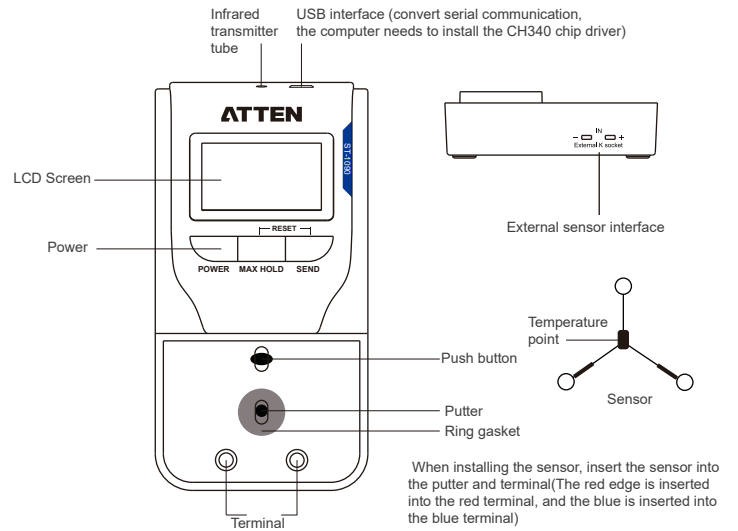

Specification:

Model	ST-1090
Resolution	1°C/1°F
Temperature range	0-800°C/32-1500°F
Accuracy Temperature	±5°C/±9°F
Sensing wire	K-type thermocouple
Display	LCD
Power	9V DC High-performance carbon battery
Operating environment	0°C~40°C/32°F~104°F
Size	75x143.5x41.5mm
Weight	185g
Package list	Host ST-1090:1 Battery: 1 K-type thermocouple test wire:1 Sensor : 10 MINI USB data line 1 Manual: 1

IR function:



A serial port function:

The serial port data line is connected to the thermometer and the computer, the thermometer displays COM as shown in Figure 4-2; the thermometer sends to the computer every 100ms temperature data.



ATTEN serial port assistant

Download ATTEN serial port assistant from the official website (You can also use other serial port assistants)

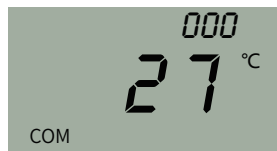
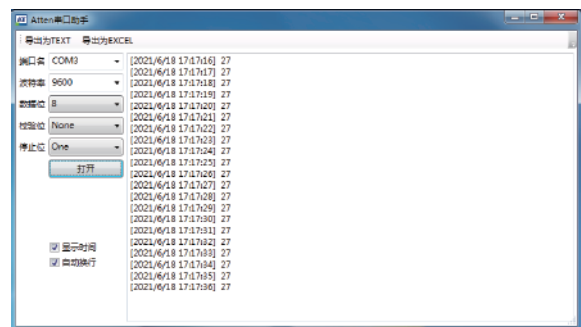



Figure4-2 (Serial communication baud rate 9600)



ATTEN serial port assistant interface

Note: convert serial communication, the computer needs to install the CH340 chip driver

Hot Melting Glue Gun

Product pictures		
Model number	JQ-050	JQ-100A
Voltage	110V~240V	
Power	50W	100W
High temperature	180°C	200°C
Glue stick	φ7mm	φ11mm

JQ-010



Full charge lasts 60 minutes

- Power: 8-10W
- High temperature: 180°C
- Glue stick: φ7mm

Glue stick



φ11mm



φ7mm

Solder Smoke Absorber

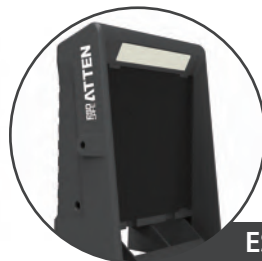

ESD safe

ST-1016/ST-1016-P

- Desktop-type with vertical and horizontal dual-use.
- Remove soldering smoke and fumes quickly and safely.
- Highly activated carbon material with strong absorb function.
- LED lighting function.

Test Data

Test Item	Test Data
Air volume (vertical) m ³ /min	1.03
Air Volume (horizontal) m ³ /min	0.4
Air flow (vertical) m/s	1.0
Air flow (horizontal) m/s	2.6
Maximum suction capacity m ³ /min	1.03

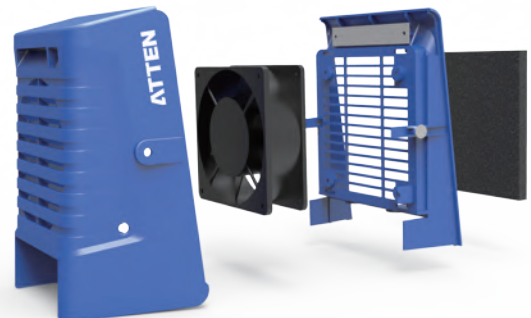

Magnifying Frame



FT-90A

- Made up of steel base, movable mechanical arm, fixed frame and magnifying glass, adjust proper height.
- The components can be adjusted in any direction.
- Use for observation / repair / circuit board (especially high-density, precision circuit board) welding of small objects as an extensive maintenance tool.

Magnification times: 3x
Diameter of glass: about 9cm
Type: Multi-direction
Weight: 516g



Tweezers



AT-110



AT-113



AT-115

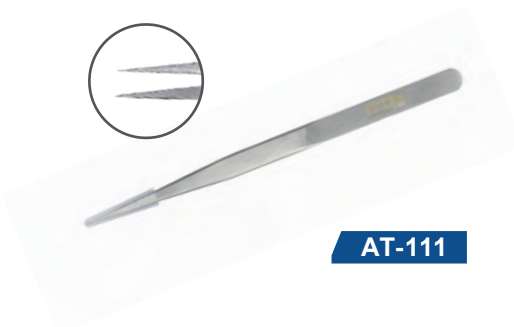

AT-111

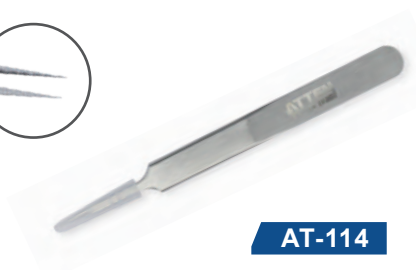

AT-114



Package

Tin-silver Soldering Wire

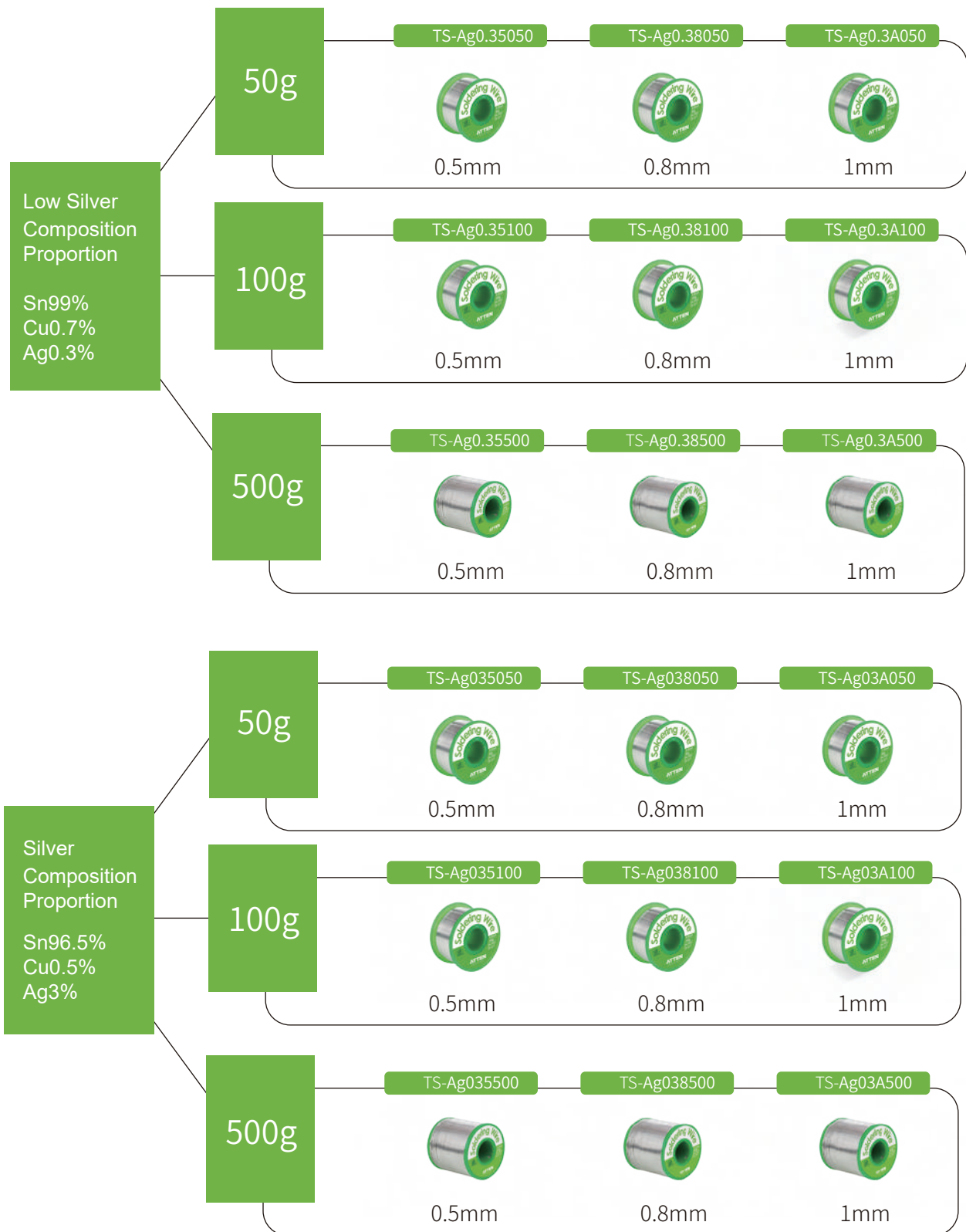

Including rosin

Stainless Steel Tin Soldering Wire

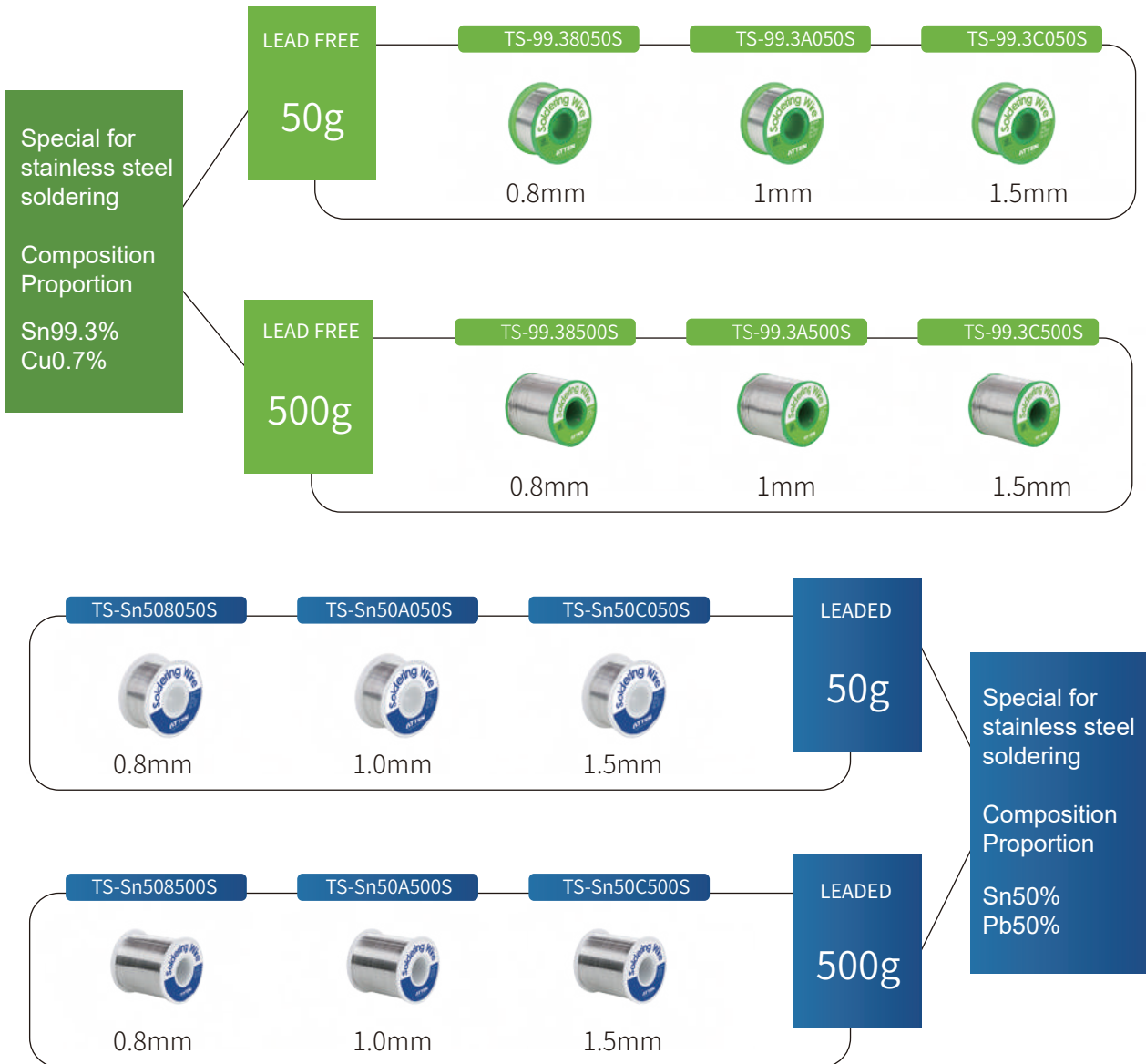

Including rosin

Note: Can not be used for PCB board welding.

Soldering Wire

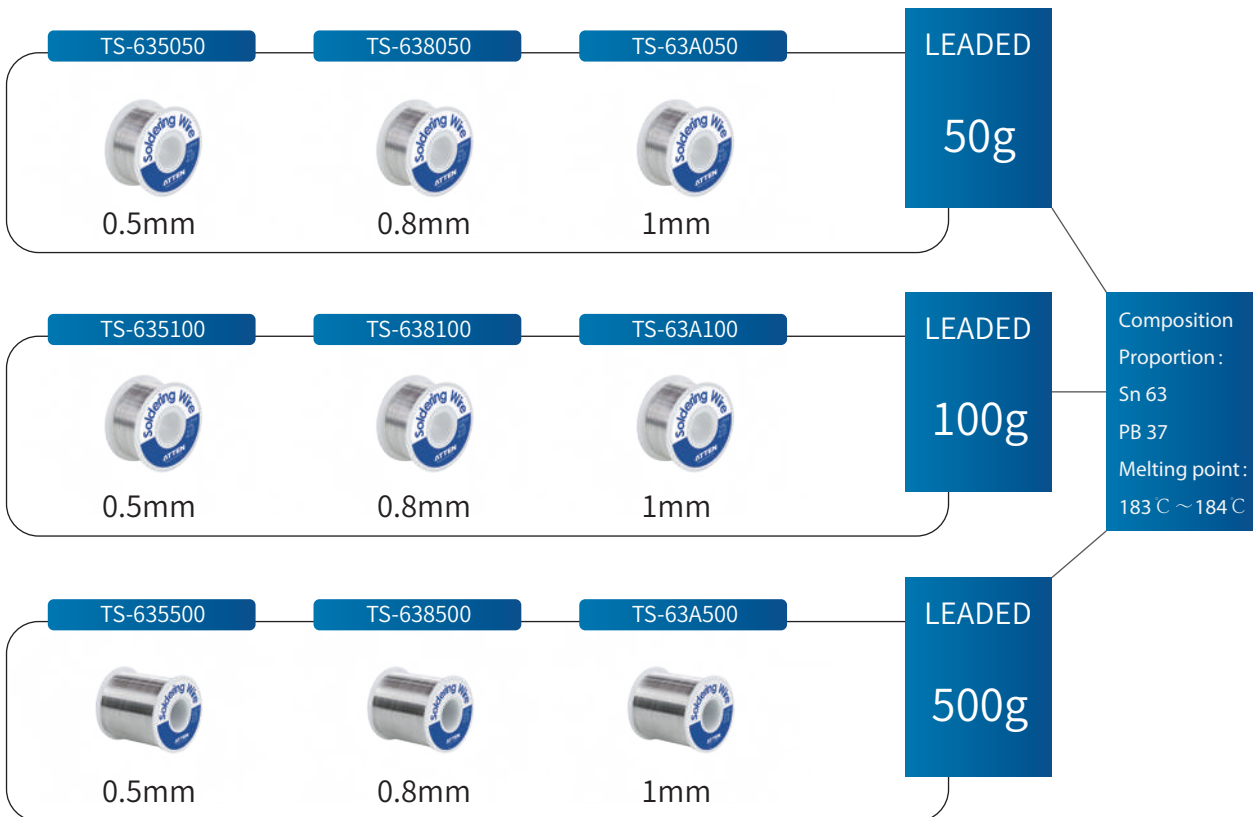
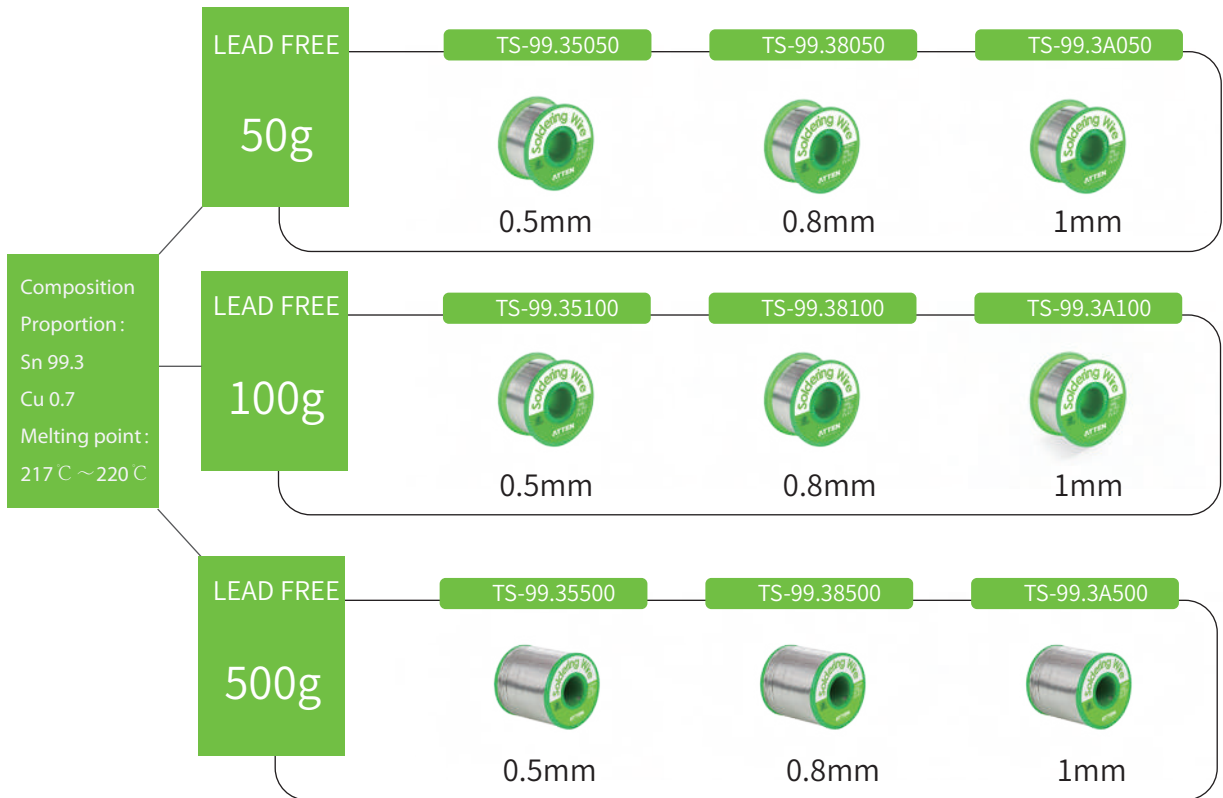

Including rosin

Soldering Tip Cleaner



CS-05B

For cleaning soldering tips.

The soldering tip is cleaned by wiping or turning it in the metal wool. subsequently, a fine solder layer will remain which prevents fast oxidation of the soldering tip, and represents a considerable advantage compared to standard sponge cleaning.

Caution

keep the product away from children.

Only use the metal wool to clean soldering tips.

Remove the soldering tip from the metal wool directly after cleaning.

Tin Slag Box



CS-08B

- Special for lean soldering tip and recycling tin residue.
- Anti-static / high temperature resistance.
- Pour out the tin block easily.
- Improving the problem of throwing tin while soldering, dirty and messy working environment, convenient to mass collect and take out after collecting, etc.

Solder Stand



S-11

- All-metal construction.
- Portable solder stand which helps.
- Work more convenience.
- The tilt angle is adjustable.

Solder Wire Stand



TJ-227

- Metal sheet base.
- The shaft can support 1kg soldering.
- The Shaft easy to take off.
- Move flexible.

TJ-228

- All-metal construction.
- Simple design.
- Soldering wire holder and sponge plate 3 in1.
- Save space, use easily.



Solder Pot

Product pictures				
Item	LT-360B	LT-350B	LT-380B	LT-310B
Power	130W	160W	250W	300W
Voltage	220V~240V	220V~240V	220V~240V	220V~240V
Temperature range	50~520°C	50~520°C	50~480°C	50~480°C
Solder capacity	0.3KG	0.5KG	1.6KG	2.2KG
Crucible Size	φ36mm	φ50mm	φ80mm	φ100mm
Melting time	10min	10min	20min	20min

Soldering Wick

AT-0815

WIDTH
0.8mm
LENGTH
1.5m



AT-1515

WIDTH
1.5mm
LENGTH
1.5m



AT-2015

WIDTH
2.0mm
LENGTH
1.5m



AT-2515

WIDTH
2.5mm
LENGTH
1.5m



AT-0820

WIDTH
0.8mm
LENGTH
2m



AT-3515

WIDTH
3.5mm
LENGTH
1.5m



AT-1520

WIDTH
1.5mm
LENGTH
2m



AT-2020

WIDTH
2.0mm
LENGTH
2m



AT-2520

WIDTH
2.5mm
LENGTH
2m



AT-3520

WIDTH
3.5mm
LENGTH
2m



Including soldering flux

Desoldering Tool

ESD safe

AT-E330A



AT-E330P

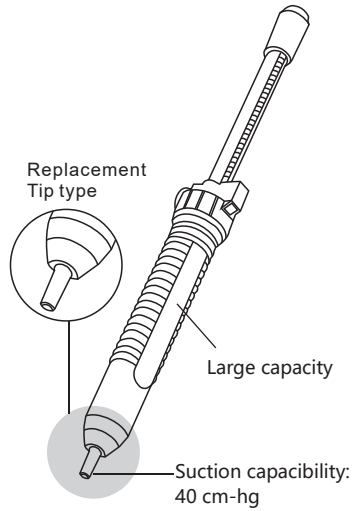
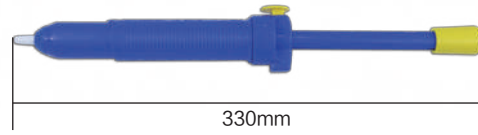

The Desoldering Pump come with high vacuum force especially made for clearing circuit boards in rework jobs and field repair.

- Piston with double oil seals: no air leakage guarantee.
- Soft handle delivers comfortable grip and non-slip function.
- Compact size.
- Anti-rust spring.
- Built-in tip for easy replacement.
- Quick and easy solder residue clearance.

AT-E210D

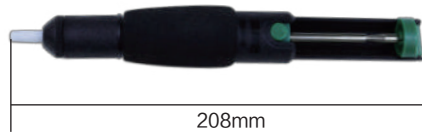

Vacuum pick-up tool



AT-B778

Item	Size	Pcs	Other
Suction disc S-1	φ3mm	2	
Suction disc S-2	φ7mm	2	
Suction disc S-3	φ10mm	2	
Suction nozzle Y-1	/	1	Straight
Suction nozzle Y-2	/	1	Bent

Tip Refresher

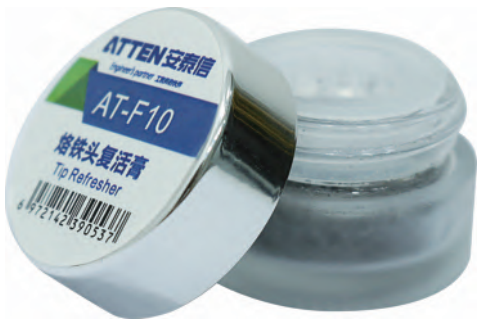

AT-F10

- Remove oxidizing material from soldering tip and tin the tip again.
- Do not contain diammonium phosphate, no damage to circuit board.
- Environmental protection, no hazardous substance.
- It's reusable.

Rosin Flux



TR-045

- Remove oxidation film.
- Prevent oxidation.
- Reduce surface tension.

Weight: 45g

Solder paste flux

AT-H20



Model	AT-H20	Dimensions	φ29x34x101mm
G.W	20g	N.W	10g
Color	Light yellow solid	Certification	ROHS

AT-H40



Model	AT-H40	Dimensions	φ59x27mm
G.W	40g	N.W	36g
Color	Light yellow solid	Certification	ROHS

AT-H60



Model	AT-H60	Dimensions	φ72x28mm
G.W	60g	N.W	56g
Color	Light yellow solid	Certification	ROHS

Wrist Strap

AT-FJ1



AT-FJ2



- Strong anti-static . The wrist strap can dissipate the static electricity of the human body
- High safety performance. The wrist strap is made of thermoplastic material with light,
- Thin and soft, it is safe to contact with human skin and easy to use.
- Strong resistance. the impedance of the wrist strap can reach $10^4\Omega$

Wrist Strap On-line Monitor

AT-518-1



Output: 6V DC
Size: 62x45x29(mm)
Weight: 41g(excluding power adapter)

Input: AC 220V
Material: ABS
Consumption: 1.8W

AT-518-2



Output: 6V DC
Size: 103x56x29(mm)
Weight: 74g(excluding power adapter)

Input: AC 220V
Material: ABS
Consumption: 1.8W



- When the grounding system of the human body wrist strap is working and operating normally:there is no voice and LED green light on.
- When the grounding system of the human body wrist strap is broken down there is alarm voice and LED red light flashing.

APS15-3A/APS22-5A

COMMUNICATION MAINTENANCE DC REGULATED VOLTAGE POWER SUPPLY



Overview

APS series communication maintenance power supply is designed for the needs of communication maintenance technicians, training schools and related engineering research and development personnel. The product adopts series type regulated voltage scheme with the current best stability and is controlled by digital MCU chip. It features very high stability and low ripple, simple operation and control, and all kinds of protection functions, especially suitable for use in the communication industry.

Application

- College training education
- Universal testing in R&D laboratory
- Maintenance of communications equipment

Specifications:

Model	APS15-3A	APS22-5A
Input Voltage	230VAC/115VAC(Optional)	
Rated output voltage	0-5V/0-15V (dual steps)	0-22V (continuously adjustable)
Rated output current	0.5A/3A (dual steps)	0-0.5A/0-5A (continuously adjustable)
Rated output power	56W (including USB interface output)	125W (including USB interface output)
Ripple and noise	$CV \leq 0.5mV_{rms}$	$CV \leq 0.5mV_{rms}(5Hz \sim 1MHz)$
Line Regulation	$CV \leq 0.01\% + 3mV$	$CV \leq 0.01\% + 3mV$ $CC \leq 0.1\% + 3mA$
Load Regulation	$CV \leq 0.01\% + 8mV$	$CV \leq 0.01\% + 4mV(I < 3A)$
set resolution	Voltage:3mV	Voltage:3mV Current:1mA
Protection Function	OCP(support automatically recovery)/OHP	OCP(support automatically recovery)/constant overcurrent/OHP
Other Functions	coarse tuning/ fine tuning switch, 5V/ 15 switch, 0.5A/ 3A switch and parameters locking	coarse tuning/ fine tuning switch, 0.5A/5A switch and parameters locking
USB interface	Fixed 5V output($\pm 5\%$), maximum 2.1A output (overcurrent protection, stop outputting)	support QC quick charge agreement maximum 3A output
Read Back Accuracy	LCD display: $\pm(0.5 \pm 2 \text{ digits})$ Current pointer display: Class-2.5	
Heat-dissipating method	Smart fan control	
Working condition	Temp:0~40°C Humidity: <80%	
Storage condition	Temp:-20~70°C Humidity: <80%	
Size(WxHxD)	88*150*215(mm)	
N.W	2.5Kg	3.6Kg

Features

- MCU-Digital control, series adjustment mode control, low ripple, low noise, and high stability.
- The double-type head design is more suitable for the use of communication equipment products.
- Fast dynamic load response speed, optimized processing for communication equipment.
- The product is designed with cut-off self-recovery protection function and over-temperature protection function.
- Independent USB interface, providing 3A current output capability, with over-current and short-circuit protection support QC quick charge agreement.
- Voltage and current are switched with two gears to adapt to different equipment.
- Built-in voltage gear automatic adjustment function, which can be more suitable for full load use.
- The digital encoder adjusts the voltage, and can switch between coarse adjustment and fine adjustment function, more precise control and longer service life.
- With output adjustment lock function, alarm prompt function, which can effectively prevent wrong operation.
- Intelligent fan control is automatically controlled according to the internal power device temperature.

TPR3003T/TPR3005T

LINEAR ADJUSTABLE DC REGULATED VOLTAGE POWER SUPPLY

Application

- Electronic products testing, verification
- Equipment maintenance, aging
- College training education
- Automotive electronic circuit power supply testing aging
- Research and development technology laboratory general test

Features

- It adopts LCD screen, high-precision double 4-bit voltage and ammeter head display, automatic calculation and display of output power.
- Rated range voltage, current continuously adjustable output.
- Constant voltage CV/ constant current CC mode automatically switch seamlessly.
- Voltage tracking output protection function, independent and perfect protection circuit.



- The product is designed with full power, super loading capacity, and can be used at full load for a long time.
- Enhanced heat dissipation system with long life double-ball fan ensure durable work, no protection.
- Panel door cover type protection to prevent wrong adjustment of parameters.

Specifications:

Model	TPR3003T	TPR3005T
Rated output voltage	0-30V	
Rated output current	0-3A	0-5A
Power supply voltage	220V±10%, 50HZ/60HZ (100V/117V/200V/217V/234V optional)	
Operation condition	temperature: 0℃~40℃ relative humidity: <80%	
Storage condition	temperature-20℃~80℃ relative humidity: <80%	
Rated output power	90W	150W
Power supply effect	CV≤0.01%+3mV CC≤0.2%+1mA	
Load effect	CV≤0.01%+5mV CC≤0.2%+5mA	CV≤0.01%+7mV CC≤0.2%+7mA
Ripple and noise	(5Hz~1MHz)CV≤0.5mVr.m.s CC≤3mAr.m.s	(5Hz~1MHz)CV≤1mVr.m.s CC≤5mAr.m.s
Display	4 digits	
Voltmeter display precision	±0.5%rdg+2 bit	
Ammeter display precision	±0.5%rdg+2 bit	
High voltage test	leak current≤1mA(test condition AC-GND 1700VAC/2s)	
Insulation impedance	insulation impedance≥7MΩ((test condition AC-GND 500VDC/5s)	
Working method	constant voltage/constant current	
Protection method	current-limiting, voltage reduction, short-circuit protection, over temperature protection, over voltage protection	
Heat-dissipating method	air cooling	
Size (WxHxD)	W125xH170xD275mm	
Standard Packing		
Inner box: 37.9x23x27.4(CM)	N.W.: 5KG G.W.: 5.3KG	N.W.: 6.2KG G.W.: 6.5KG

TPR32-5A / TPR75-2A

LINEAR PROGRAM-CONTROLLED ADJUSTABLE REGULATED VOLTAGE POWER SUPPLY

Application

- Universal testing in R&D laboratory
- Pure power supply for radio frequency, microwave circuits or components
- Feature verification and fault diagnosis of devices or circuits
- Quality control and quality inspection
- Power supply for automotive electronic circuits
- Teaching experiments
- Production automation testing

Features

- It adopts double four-position high-precision voltage, ammeter head and pure MCU digital control output for better stability and higher precision.
- Product constant voltage CV / constant current CC mode, which enables continuously adjustable output within the rated range.
- It can be converted to external control mode, external input control voltage, used to control the main power supply voltage and current output.
- It has extended master-slave parallel, series operation mode, which is more convenient for user to use series-parallel expansion.
- Provide 10 convenient and fast parameter storage functions (including OVP and OCP setting values), which is convenient for users to quickly and directly call the output
- Provide external monitoring function for main output voltage and current parameters, which can be connected to a higher precision meter for display.
- It has functions of storable output parameters, status lock, and alarm.
- The intelligent cooling system adopts a double ball fan to automatically control the fan speed according to the internal temperature, making it quieter and longer-lived.
- Support computer program control, standard RS232 communication interface.



Specifications:

Model	TPR32-5A	TPR75-2A
Power supply voltage	AC 240V/230V/220V/110V/120V Optional	
Rated output voltage	0~32V	0~75V
Rated output current	0~5A	0~2A
Rated output power	160W	150W
Ripple and noise	CV \leq 0.5mVrms CC \leq 1mArms	CV \leq 1mVrms CC \leq 1mArms
Power supply effect	CV \leq 0.01%+3mV CC \leq 0.2%+3mA	CV \leq 0.01%+5mV CC \leq 0.2%+2mA
Load effect	CV \leq 0.01%+5mV CC \leq 0.2%+3mA	CV \leq 0.01%+3mV CC \leq 0.2%+5mA
Display accuracy	$\pm(0.5\%rdg+2 \text{ Digit})$	Voltage: $\pm(0.5\%rdg+3 \text{ Digit})$ Current: $\pm(0.5\%rdg+2 \text{ Digit})$
Protection functions	OVP/OCP/OHP Protection	
Heat-dissipating method	Intelligent speed regulation air cooling	
Operating temperature	Temp: 0~40 °C Humidity: <80%	
Storage temperature	Temp: -20~70 °C Humidity: <80%	
Size (WxHxD)	W125xH170xD260mm	
Standard Packing	Inner box: 34x20x25(cm)	N.W:4.3KG G.W:5KG

TPR6005T/TPR6010T

HIGH POWER CC/CV LINEAR POWER SUPPLY

Application

- Automotive electronic testing
- Photovoltaic new energy field
- Education, scientific research, laboratory
- Electromechanical field
- LED lighting field
- Other testing, product aging testing

Features

- High-resolution voltage/current display (4-digit display).
- Low ripple, low noise and pure DC output, with high reliability.
- Both voltage/current adjustments use 10-turn high-precision potentiometer knobs.
- With constant voltage CV/constant current CC mode, continuously adjustable output within the rated range.
- Provide perfect protection function, the product is suitable for various environments.
- Intelligent heat dissipation, temperature control double ball fan, low noise heat dissipation.
- With remote compensation function, it can effectively ensure product accuracy when used remotely.



Specifications:

Model	TPR6010T	TPR6005T
Rated output power	600W	300W
Rated output voltage	0~60V	0~60V
Rated output current	0~10A	0~5A
Power supply voltage	230VAC/115VAC(Optional)	
Voltage		
Power supply effect	$\leq 0.005\% + 1\text{mV}$	
Voltmeter display precision	$\pm(0.1\% + 2\text{digits})$	
display resolution	10mV	
Load effect	$\leq 10\text{mV}$	
Voltage ripple	0.8mV(rms)	
Current		
Power supply effect	$\leq 1\text{mA}$	
Voltmeter display precision	$\pm(0.2\% + 2\text{digits})$	
display resolution	1mA	
Load effect	$\leq 2\text{mA}$	
Current ripple	$\leq 4\text{mA(rms)}$	
Protection functions	OVP/OCP/OHP Protection	
Heat-diss-pating method	Intelligent speed regulation air cooling	
N.W	13.5KG	11KG
Size(W*H*D)	270*178*350(mm)	

TPR3020T/TPR3010T

HIGH POWER CC/CV LINEAR POWER SUPPLY

Application

- Automotive electronic testing
- Photovoltaic new energy field
- Education, scientific research, laboratory
- Electromechanical field
- LED lighting field
- Other testing, product aging testing

Features

- High-resolution voltage/current display (4-digit display).
- Low ripple, low noise and pure DC output, with high reliability.
- Both voltage/current adjustments use 10-turn high-precision potentiometer knobs.
- With constant voltage CV/constant current CC mode, continuously adjustable output within the rated range.
- Provide perfect protection function, the product is suitable for various environments.
- Intelligent heat dissipation, temperature control double ball fan, low noise heat dissipation.
- With remote compensation function, it can effectively ensure product accuracy when used remotely.



Specifications:

Model	TPR3020T	TPR3010T
Rated output power	640W	320W
Rated output voltage	0~32V	0~32V
Rated output current	0~20A	0~10A
Power supply voltage	230VAC/115VAC(Optional)	
Voltage		
Power supply effect	$\leq 0.005\% + 1\text{mV}$	
Voltmeter display precision	$\pm(0.1\% + 2\text{digits})$	
display resolution	10mV	
Load effect	$\leq 15\text{mV}$	$\leq 10\text{mV}$
Voltage ripple	0.8mV(rms)	
Current		
Power supply effect	$\leq 2\text{mA}$	$\leq 1\text{mA}$
Voltmeter display precision	$\pm(0.2\% + 2\text{digits})$	
display resolution	10mA	1mA
Load effect	$\leq 3\text{mA}$	$\leq 2\text{mA}$
Current ripple	$\leq 6\text{mA(rms)}$	$\leq 4\text{mA(rms)}$
Protection functions	OVP/OCP/OHP Protection	
Heat-diss-pating method	Intelligent speed regulation air cooling	
N.W	13.5KG	11KG
Size(W*H*D)	270*178*350(mm)	

KPS3030DA/KPS3050DA

HIGH POWER ADJUSTABLE DC REGULATED VOLTAGE POWER SUPPLY

Application

- Automotive electronic testing
- Photovoltaic new energy field
- Education, scientific research, laboratory
- Electromechanical field
- LED lighting field
- Other testing, product aging use

Features

- The product has functions of adjustable constant voltage and constant current, and automatically switches state according to load.
- Switching power supply structure, with features of high power, high efficiency, light weight and strong load capacity.
- Perfect protection function, short-circuit protection, over-temperature protection, over-voltage protection.
- The voltage adjustment is made by multi-turn potentiometer, with higher adjustment accuracy.
- automatically High-power temperature-controlled fan dissipates heat according to the internal temperature of the machine.
- Full power design with high reliability.



Specifications:

Model	KPS3030DA	KPS3050DA
Rated output voltage	0-30V	
Rated output current	0-30A	0-50A
Power supply voltage	220V±10%, 50Hz/60Hz	
Operation condition	temperature: 0°C~40°C relative humidity: <80%	
Storage condition	temperature-10°C~70°C relative humidity: <80%	
Rated output power	900W	1500W
Power supply effect	CV≤0.01%+3mV CC≤0.1%+6mA	
Load effect	CV≤0.01%+10mV(1≤10A) CC≤0.1%+6mA(1≤10A)	
Ripple and noise	CV≤50mVr.m.s	
Voltmeter display precision	±(0.5% of rdng+2 digits)	
Ammeter display precision	±(0.5% of rdng+2 digits)	
High voltage test	leak current≤1mA(test condition AC-GND 1700VAC/2s)	
Insulation impedance	insulation impedance≥7MΩ (test condition AC-GND 500VDC/5s)	
Working method	constant voltage/constant current	
Protection method	current-limiting, voltage reduction, short-circuit protection, over temperature protection, over voltage protection	
Heat-dissipating method	air cooling	
Size (WxHxD)	W260xH170xD380mm	
Standard Packing		
Inner box: 41x32x23 (CM)	N.W.: 6KG G.W.: 6.3KG	N.W.: 7KG G.W.: 7.3KG

TPS300P

DC SWITCHING POWER SUPPLY



Overview

TPS series power supply is a high-precision, high-reliability, constant-voltage, constant-current, constant-power switching linear regulated power supply. The product adopts innovative double voltage-regulated structure of switch regulated voltage + linear regulated voltage, and also features high efficiency and high power of switching power supply, and the low ripple and high reliability of the linear power supply.

Application

- Automated testing
- LED lighting field
- Photovoltaic new energy field
- Education, scientific research, laboratory
- Electromechanical field
- Automotive electronic testing
- Other tests, product aging use

Features

- High precision voltage, ammeter head and pure MCU digital control output for better stability and higher precision.
- Dual voltage stabilizing structure, high efficiency, low ripple, low noise output.
- Product constant voltage CV / constant current CC mode, which enables continuously adjustable output within the rated range.
- It can be converted to external control mode, external input control voltage, used to control the main power supply voltage and current output.
- It has extended master-slave parallel, series operation mode, which is more convenient for user to use series-parallel expansion.
- Provide 10 convenient and fast parameter storage functions (including OVP and OCP setting values), which is convenient for users to quickly and directly call the output
- Provide OVP, OCP, OHP protection and alarm functions.
- Provide external monitoring function for main output voltage and current parameter.
- It has functions of storable output parameters, status lock, and alarm.
- The intelligent cooling system adopts a double ball fan to automatically control the fan speed according to the internal temperature, making it quieter and longer-lived.
- Support computer program control, standard RS232 communication interface.

Specifications:

Model	TPS300P	
Rated output voltage	0~75V	
Rated output current	0~10A(Limited by output power)	
Power supply voltage	AC 115V / 230V 50~60HZ(Optional)	
Rated output power	300W	
Setting accuracy	CV: $\pm(0.1\%\text{set}+0.05\%\text{rating})$	CC: $\pm(0.3\%\text{set}+0.1\%\text{rating})$
display accuracy	CV: $\pm(0.1\%\text{rdng}+2\text{digits})$	CC: $\pm(0.2\%\text{rdng}+2\text{digits})$
Power adjustment rate	CV: $\leq 0.01\%+3\text{mV}$	CC: $\leq 0.1\%+5\text{mA}$
Load regulation	CV: $\leq 0.01\%+5\text{mV}(<5\text{A})$	CC: $\leq 0.01\%+5\text{mA}$
Ripple	CV: $\leq 5\text{mVrms}$	CC: $\leq 3\text{mArms}$
Dynamic response	$\leq 100\mu\text{s}$	
Quick access	10 group (Contain OVP OCP)	
Protection functions	OVP/OCP/OHP	
Heat-dissipating method	Smart fan control	
Weight	G.W.: 3KG	
Size(WxHxD)	125x170x260(mm)	

CP600-30V/30A/CP900-30V/30A

HIGH POWER PROGRAM-CONTROLLED DC REGULATED VOLTAGE POWER SUPPLY

Overview

CP series power supply is a high-precision, high-reliability, constant-voltage, constant-current, constant-power switching linear regulated power supply. The product adopts innovative double voltage-regulated structure of switch regulated voltage + linear regulated voltage, and also features high efficiency and high power of switching power supply, and the low ripple and high reliability of the linear power supply.

Application

- Automated testing
- Automotive electronic testing
- Photovoltaic new energy field
- Education, scientific research, laboratory
- Electromechanical field
- LED lighting field
- Other tests, product aging use



Features

- The product is suitable for 100-240V AC universal AC input, universal use for the global power grid.
- Pure digital MCU control, long-term use to ensure product accuracy, long service life, and low temperature drift.
- High-precision setting and read-back display, built-in 16-bit D/A 20-bit A/D converter
- The product has high efficiency and built-in power factor correction circuit.
- Pure hardware OVP, OCP, OHP, OPP protection, OVP/OCP protection values can be set separately.
- Front switch regulated voltage + post linear regulated voltage, double regulated voltage structure, high efficiency, and low ripple.
- With local or remote voltage acquisition, and automatic compensation function. Long-distance measurement can also ensure accuracy.
- Provide 3 groups of quick parameter storage function to quickly call the settings.
- Provide coarse adjustment and fine adjustment functions. Voltage setting accuracy is up to 1mV, current 1mA.
- Intelligent temperature-controlled fan, automatically controlling the speed of heat dissipation.
- Standard USB, RS232 communication interface, which can be connected and controlled with the PC.

Specifications:

Model		CP600-30V/30A	CP900-30V/30A
AC input	Input voltage	220-240V AC	
	Frequency	47-63Hz	
	(PFC)	>0.98	
Output	Output power	0-600W (CP)	0-900W
	Output voltage	0-31V	0-31V
	Output current	0-31A	0-31A
Working method		CV/CC/CP	CV/CC
Voltage	Setting resolution	1mV	1mV
	Maximum preset voltage(105% of rating)	31V	31V
	Setting accuracy	0.05%set + 20mV	
	Line regulation	0.01% +5mV	
	Load regulation	0.1% + 5mV	
	Voltage display resolution	10mV	
	Voltage display accuracy	±(0.05% of reading + 2digits) at 23±5°C	
	Ripple noise	100mVp-p/10mVrms	
	Rise time (Rated Load)	150mS	
	Fall time (No Load)	150mS	
	Temperature coefficient	100ppm/°C(TYP Value)	
Current	Setting resolution	1mA	
	Maximum preset current (105% of rating)	31A	31A
	Setting accuracy	0.1% set +0.1% rating	
	Line regulation	0.1%+10mA	
	Load regulation	0.2%+10mA	
	Ripple noise	50mA	
	Temperature coefficient	200ppm/°C	
	Current display resolution	1mA(≤ 10A) / 10mA(≥ 10A)	
Current display accuracy	±(0.2% of reading + 30 digits) at 23±5°C		
Protection functions OVP range:0.3V-Rated Voltage+1.5V OCP range:0.3V-Rated Voltage+1.5A		OVP、OCP、OHP、OPP、SCP(short circuit protection)	
Efficiency(full load)		≥85%	
Communication method		USB、RS232	
Product size		W190xH125xD330mm	
Standard packing			
Inner box: 42.8x29.5x22.2 (cm)		N.W: 4.1KG	G.W: 5.1KG

PR35-3A-3C / PR35-5A-3C

THREE-WAY LINEAR DC REGULATED VOLTAGE POWER SUPPLY

Overview

This product has high precision, high reliability, adjustable constant voltage, constant current DC regulated voltage. The product has the advantages of simple operation, durability and complete functions.

Application

- Universal testing in R&D laboratory
- Pure power supply for radio frequency, microwave circuits or components
- Feature verification and fault diagnosis of devices or circuits
- Quality control and quality inspection
- Power supply for automotive electronic circuits
- Teaching experiments
- Production automation testing



Panel turnover effect

Features

- The product adopts double four-position voltage, current display with high precision, high reliability, low ripple, low noise, low temperature drift characteristics.
- Independent hardware OVP, OCP protection, OHP protection, fast response, one step faster.
- OVP, OCP protection value can be set separately, and the application range is wider.
- Quick series and parallel operation, no need for external adapter cable, more convenient to use.
- In the series and parallel state, pure hardware shares the same current, fast dynamic response speed, which is more conducive to accurate test.
- Fully digital MCU control, button, encoder operation, longer service life, long-term guarantee of product accuracy.
- The three-way power supply is completely isolated from output, operated independently, and does not interfere with each other.
- Panel door cover protection to prevent wrong operation.
- Intelligent fan cooling system with built-in linear temperature sensor to control fan speed, with low noise and more silence.

Specifications:

Model	PR35-3A-3C			PR35-5A-3C		
Output Specification	Channel 1	Channel 2	Channel 3	Channel 1	Channel 2	Channel 3
Rated output power	105W	105W	5W	175W	175W	5W
	215W			355W		
Voltage						
Rated output voltage	35V		5V(Fixed)	35V		5(Fixed)
Maximum preset voltage	105% of rating (V)		–	105% of rating(V)		–
Setting resolution	1mV		–	1mV		–
Setting accuracy	0.2% set + 0.1% rating		–	0.2% set + 0.1% rating		–
Display accuracy	±(0.5% of rdng+2 digits)		–	±(0.5% of rdng+2 digits)		–
Line regulation	3mV		–	4mV		–
Load regulation	10mV		–	10mV		–
Transient response	50us		–	50us		–
Ripple noise	0.5mV(rms)		–	0.5mV(rms)		–
Current						
Current	3A		1A	5A		1A
Maximum preset current	105% of rating(A)		–	105% of rating(A)		–
Setting resolution	0.1mA		–	0.1mA		–
Setting accuracy	0.3% set +0.1% rating		–	0.3% set +0.1% rating		–
Display accuracy	±(1% of rdng+5 digits)		–	±(1% of rdng+5 digits)		–
Line regulation	5mA		–	5mA		–
Load regulation	5mA		–	5mA		–
Ripple noise	1mA(rms)		–	2mA(rms)		–
Temperature coefficient	200ppm/°C(ty p)					
Protection functions	OVP/OCP/OHP					
Series/Parallel Specification						
Voltage Tracking Characteristic	Series	≤300mV		–	≤300mV	
	Parallel	≤200mV		–	≤200mV	
Input Specification						
Nominal input rating	100V、117V、200V、217V (220V) 、234V (Factory Preset Parameter) ±10%					
Frequency	50/60Hz					
Dimension(WxHxD)	W250xH186xD385mm					
Environmental conditions						
Operating temperature	0°C to +40°C					
Operating humidity	< 85%RH					
Standard Packing						
Inner box: 47.6x35.6x27.5(CM)	N.W.: 12.4KG		G.W.: 12.8KG		N.W.: 14.2KG G.W.: 14.6KG	

PR35-3A-3CP / PR35-5A-3CP

THREE-WAY PROGRAMMABLE LINEAR DC REGULATED VOLTAGE POWER SUPPLY

Overview

This product has high precision, high reliability, adjustable constant voltage, constant current DC regulated voltage. The product has the advantages of simple operation, durability and complete functions.

Application

- Universal testing in R&D laboratory
- Pure power supply for radio frequency, microwave circuits or components
- Feature verification and fault diagnosis of devices or circuits
- Quality control and quality inspection
- Power supply for automotive electronic circuits
- Teaching experiments
- Production automation testing



Panel turnover effect

Features

- The product adopts double four-position voltage, current display with high precision, high reliability, low ripple, low noise, low temperature drift characteristics.
- Independent hardware OVP, OCP protection, OHP protection, fast response, one step faster.
- OVP, OCP protection value can be set separately, and the application range is wider.
- Quick series and parallel operation, no need for external adapter cable, more convenient to use.
- In the series and parallel state, pure hardware shares the same current, fast dynamic response speed, which is more conducive to accurate test.
- Fully digital MCU control, button, encoder operation, longer service life, long-term guarantee of product accuracy.
- The three-way power supply is completely isolated from output, operated independently, and does not interfere with each other.
- Panel door cover protection to prevent wrong operation.
- Intelligent fan cooling system with built-in linear temperature sensor to control fan speed, with low noise and more silence.
- The remote control interface supports IEEE std 482.2-1999 and SCPI Specification 1999.0.

Specifications:

Model	PR35-3A-3CP			PR35-5A-3CP		
Output Specification	Channel 1	Channel 2	Channel 3	Channel 1	Channel 2	Channel 3
Rated output power	105W	105W	5W	175W	175W	5W
	215W			355W		
Voltage						
Rated output voltage	35V		5V(Fixed)	35V		5(Fixed)
Maximum preset voltage	105% of rating (V)		–	105% of rating(V)		–
Setting resolution	1mV		–	1mV		–
Setting accuracy	0.2% set + 0.1% rating		–	0.2% set + 0.1% rating		–
Display accuracy	±(0.5% of rdng+2digits)		–	±(0.5% of rdng+2digits)		–
Line regulation	3mV		–	4mV		–
Load regulation	10mV		–	10mV		–
Transient response	50us		–	50us		–
Ripple noise	0.5mV(rms)		–	0.5mV(rms)		–
Current						
Current	3A		1A	5A		1A
Maximum preset current	105% of rating(A)		–	105% of rating(A)		–
Setting resolution	0.1mA		–	0.1mA		–
Setting accuracy	0.3% set +0.1% rating		–	0.3% set +0.1% rating		–
Display accuracy	±(1% of rdng+5 digits)		–	±(1% of rdng+5 digits)		–
Line regulation	5mA		–	5mA		–
Load regulation	5mA		–	5mA		–
Ripple noise	1mA(rms)		–	2mA(rms)		–
Temperature coefficient	200ppm/°C(typ)					
Protection functions	OVP/OCP/OHP					
Series/Parallel Specification						
Voltage Tracking Characteristic	Series	≤300mV		–	≤300mV	
	Parallel	≤200mV		–	≤200mV	
Input Specification						
Nominal input rating	100V、117V、200V、217V (220V)、234V (Factory Preset Parameter) ±10%					
Frequency	50/60Hz					
Dimension(WxHxD)	W250xH186xD385mm					
Environmental conditions						
Operating temperature	0°C to +40°C					
Operating humidity	< 85%RH					
Communication interface	RS232/USB					
Standard Packing						
Inner box: 47.6x35.6x27.5(CM)	N.W.: 12.6KG		G.W.: 13KG		N.W.: 14.4KG G.W.: 14.8KG	



ISO9001:2015



Engineer's partner



SHENZHEN ATTEN TECHNOLOGY CO.,LTD

Add: 8 Floor, Building 2, Senyang High-tech Park, No. 7 Road,
Guangming District, Shenzhen 518132, China

Tel: +86-755-2697-6181

Web: www.atten.com

Email: sales@atten.com.cn

